

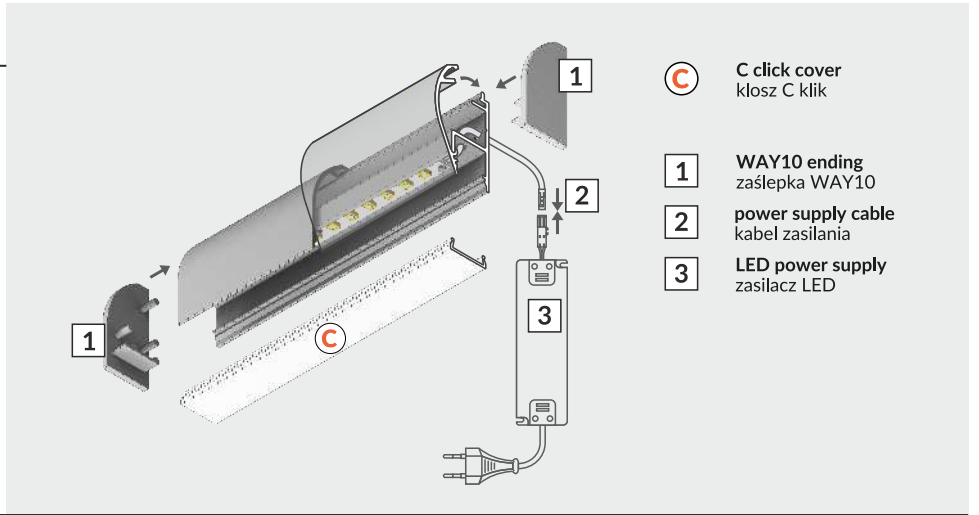

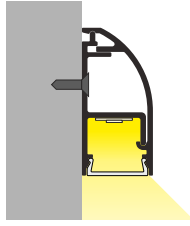

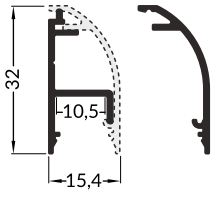



WAY10 C

SPECIAL APPLICATION PROFILE / PROFIL SPECJALNY

 max 10 mm



- C** C click cover
klosz C klik
- 1** WAY10 ending
zaślepka WAY10
- 2** power supply cable
kabel zasilania
- 3** LED power supply
zasilacz LED

-  **scissors**
nożyczki
-  **hacksaw**
piłka
-  **pliers**
kombinerki
-  **solder**
cyna
-  **soldering iron**
lutownica
-  **screwdriver**
wkrętak
-  **drill**
wiertarka

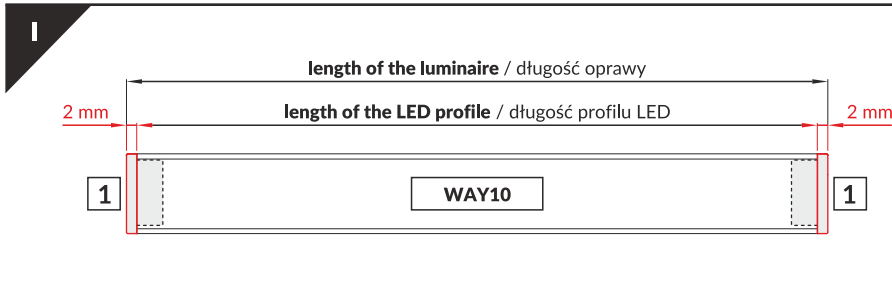

II

The length of the cover is equal to the length of the profile.
Długość klosza równa jest długości profilu.

III

Holes for the power supply cable
Otwory pod przewód zasilający

IV

Mounting holes
Otwory montażowe

V

VI

VII

VIII

IX

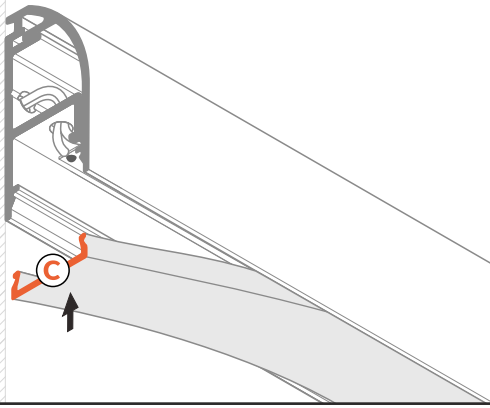

X

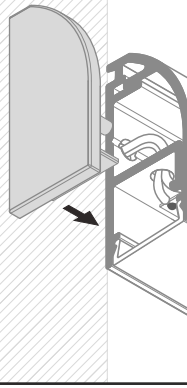

XI POWER SUPPLY / ZASILANIE

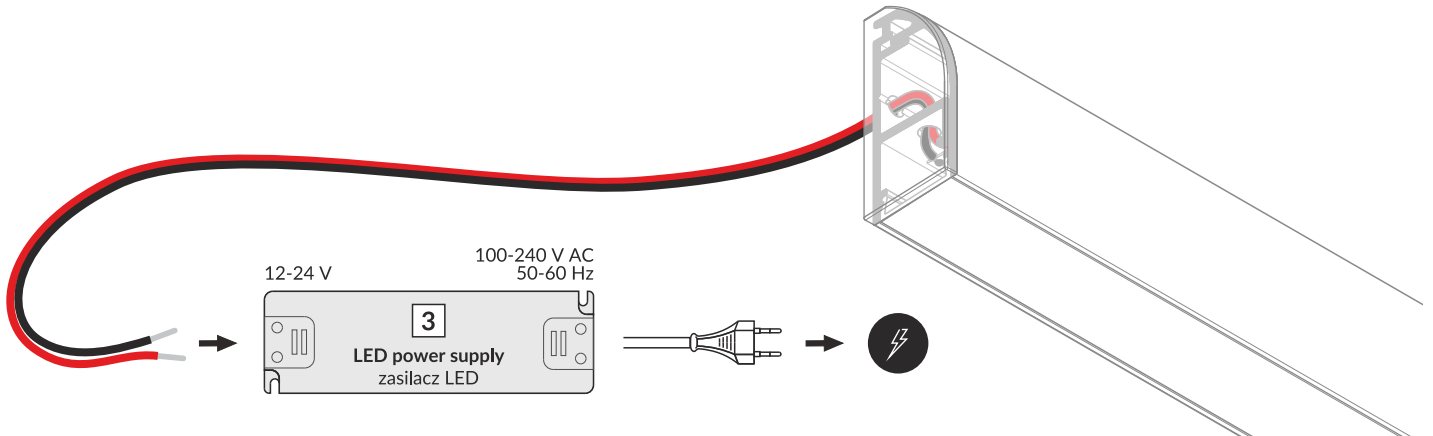

ACCESSORIES / AKCESORIA

power switches / włączniki
 controller + remote / sterownik + pilot
 movement sensors / czujniki ruchu

TOPMET Light Kłósowicz Wiśniewski i Wspólnik Sp.J.
 Ostrowska 354 | 61-312 Poznań | POLAND
 tel.: +48 61 872 75 00
 www.topmet.pl/en

03.2020

 TOPMET®