

LED PROFILE SURFACE14 EE7F/TY 1000 ANOD.







Surface



Furniture



max 14 mm

	<ul style="list-style-type: none"> • hidden mounting • many system accessories available 	<ul style="list-style-type: none">  EU industrial designs  CE  Made in Poland 	 <p>Buy product</p>
---	--	---	--

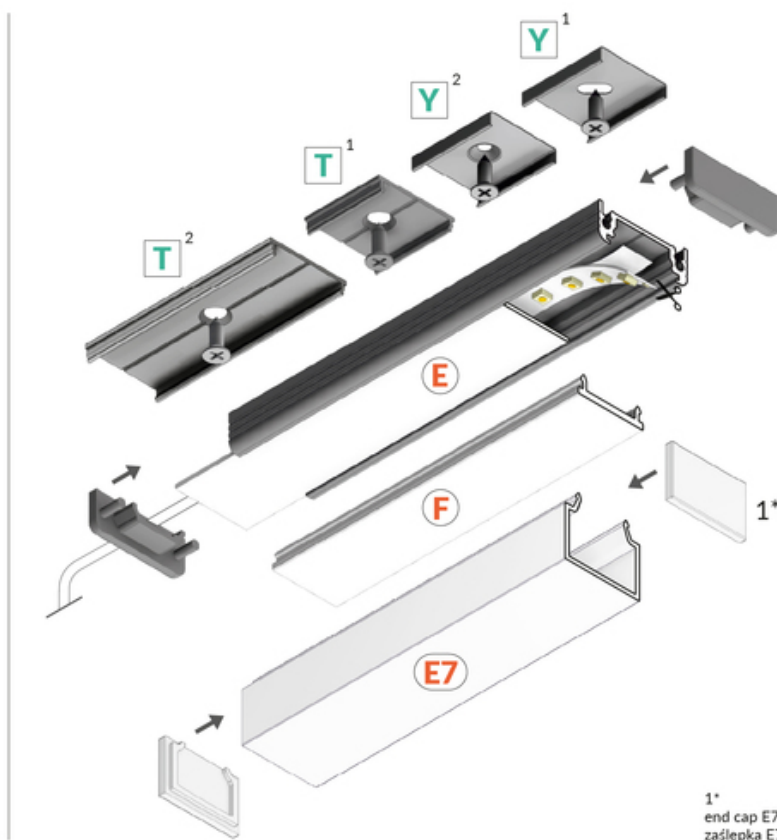
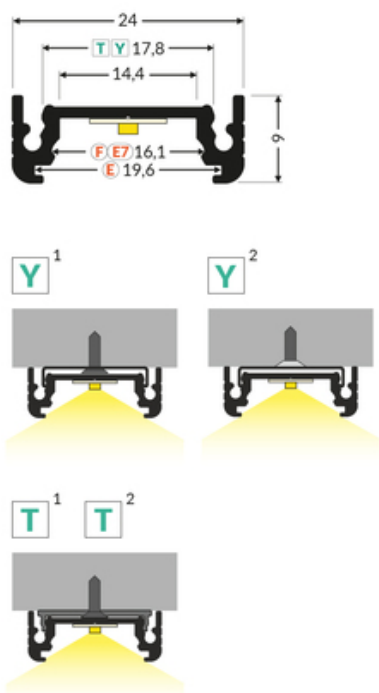

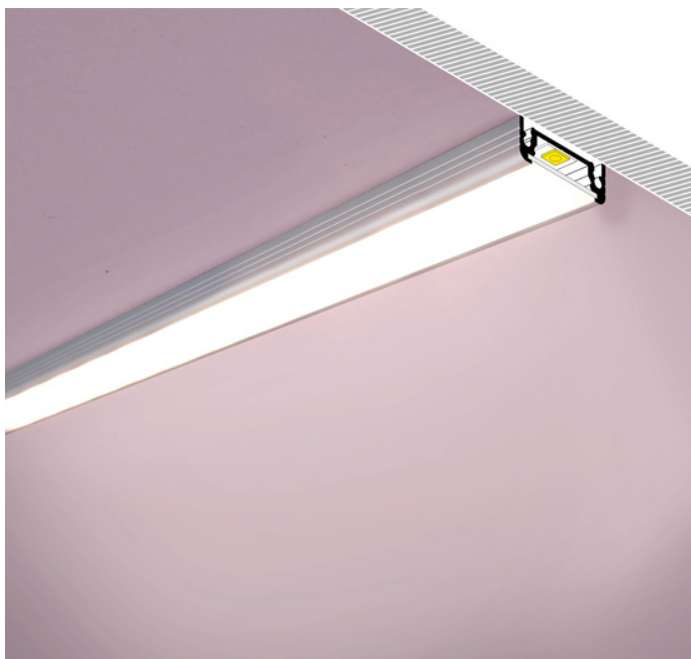

Basic Informations

EAN: 5901597204831
Index: A2010020
Material: aluminium
Color: anodized
Length [mm]: 1000
Weight [kg]: 0.163
Net weight [kg]: 0.012
Country of origin: PL

Measurement unit: qty
Product packaging dimensions [mm]: 1000 x 24 x 9
Bulk packing [qty]: 40
Master packaging type: Bulk
Product with gross packaging weight [kg]: 6.52

AVAILABLE COLORS

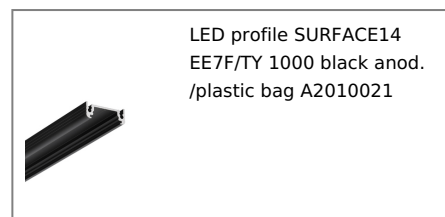
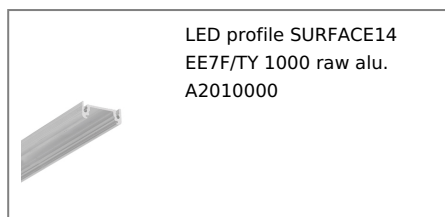
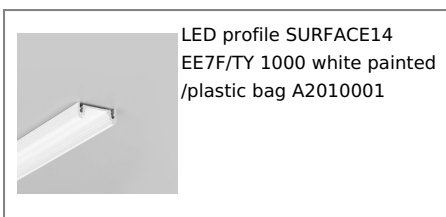

AVAILABLE VARIANTS

1000 mm, 2000 mm, 3000 mm, 4050 mm

Matching elements

TOPMET LIGHT KŁOSOWICZ WIŚNIEWSKI sp. z o.o.
Ostrowska 354 | 61-312 Poznań | POLAND
tel.: +48 61 872 75 00
info@topmet.pl

pdf card generation date: 10.03.2025



DIFFUSERS

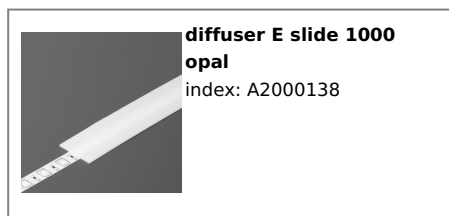

MOUNTINGS

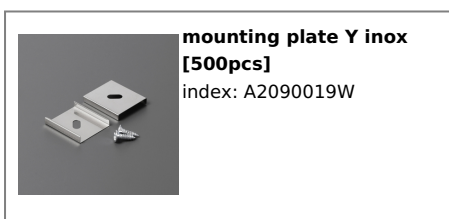

END CAPS

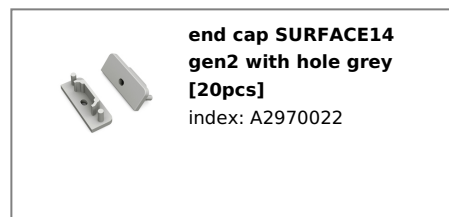
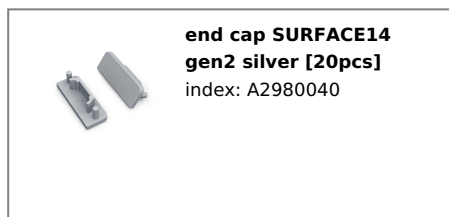

TOPMET LIGHT KŁOSOWICZ WIŚNIEWSKI sp. z o.o.

Ostrowska 354 | 61-312 Poznań | POLAND

tel.: +48 61 872 75 00

info@topmet.pl

pdf card generation date: 10.03.2025



**end cap SURFACE14
gen2 with hole silver**
[20pcs]
index: A2970040

CONNECTORS



**connector SURFACE14
90deg anod. /plastic bag**
index: A2990020



**connector T 180deg
/plastic bag**
index: C6990000



**connector T 180deg
/plastic bag [200pcs]**
index: C6990000W