

LED PROFILE PHIL RECESSED C10 2000 WHITE PAINTED

/PLASTIC BAG



Recessed



Lighting



- profile for creating LED luminaires
- perfect as main lighting
- 3 types of covers available with different light distributions



EU industrial designs



CE



Made in Poland



Buy product

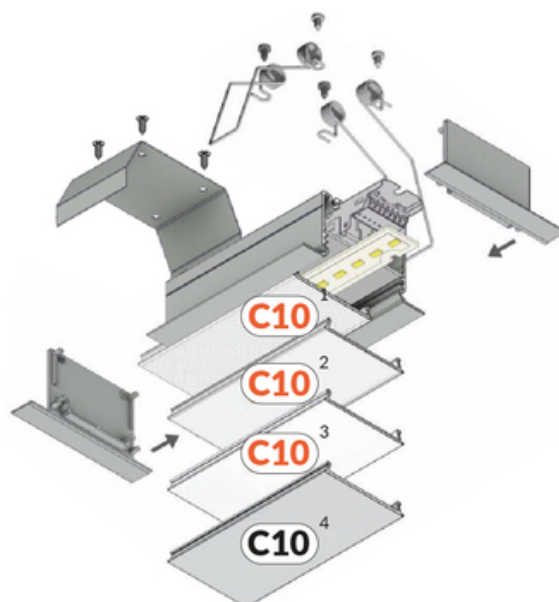
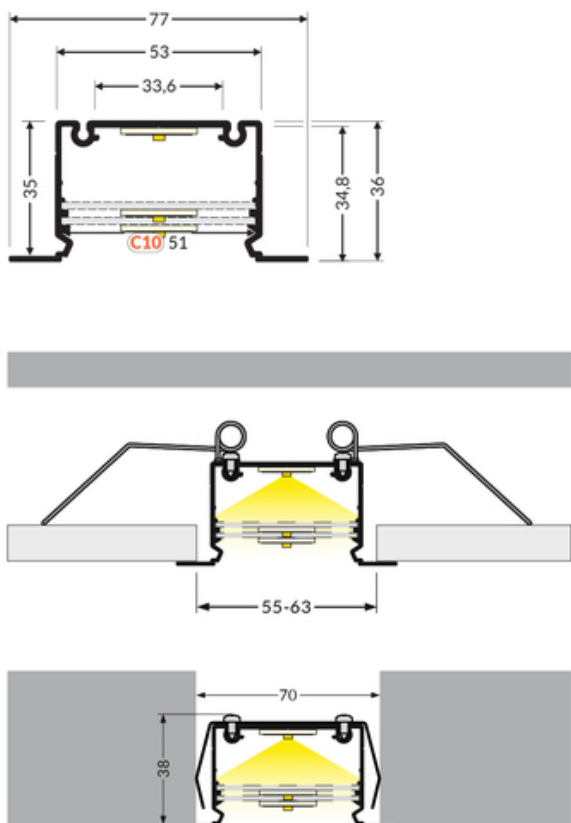

TOPMET LIGHT KŁOSOWICZ WIŚNIEWSKI sp. z o.o.

Ostrowska 354 | 61-312 Poznań | POLAND

tel.: +48 61 872 75 00

info@topmet.pl

pdf card generation date: 10.03.2025



Basic Informations

<p>EAN: 5901597200857 Index: 97100001 Material: aluminium Color: white painted Length [mm]: 2000 Weight [kg]: 1.328 Net weight [kg]: 0.0150000000000001 Country of origin: PL</p>	<p>Measurement unit: qty Product packaging dimensions [mm]: 2000 x 77 x 36 Bulk packing [qty]: 8 Master packaging type: Carton Product with gross packaging weight [kg]: 12.324</p>
--	---

AVAILABLE COLORS

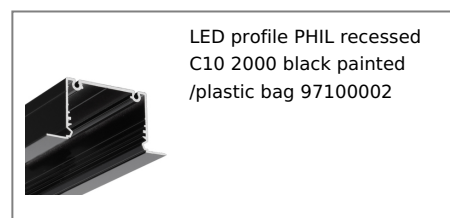
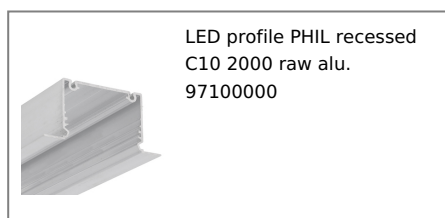

AVAILABLE VARIANTS

1000 mm, 2000 mm, 3000 mm, 4050 mm

Matching elements

DIFFUSERS

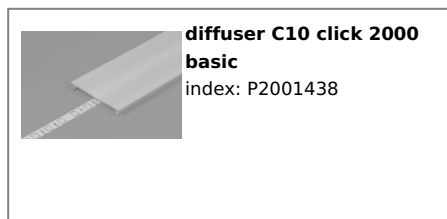
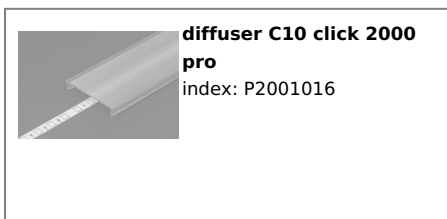

END CAPS



MOUNTING PLATES

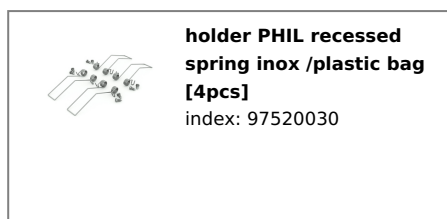
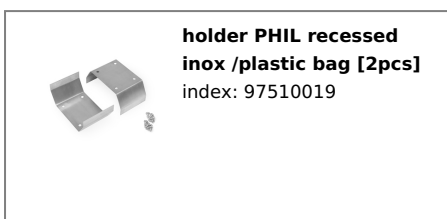

COMPLEMENTARY PROFILE

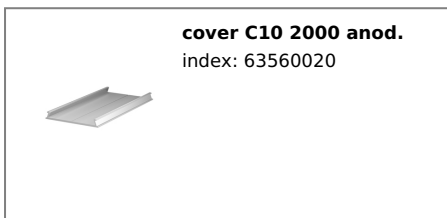

cover C10 2000 raw alu.
index: 63560000

