

INSTALLATION INSTRUCTION
LED STEP LIGHT
VT-1109 RD

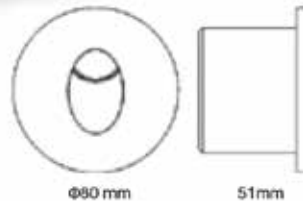

INTRODUCTION

Thank you for selecting and buying V-TAC LED product. V-TAC will serve you the best. Please read these instructions carefully before starting the installing and keep this manual handy for future reference. If you have any other query, please contact our dealer or local vendor from whom you have purchased the product. They are trained and ready to serve you at the best.

STRUCTURE & SIZE

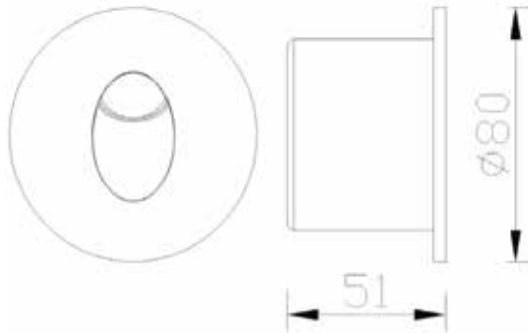
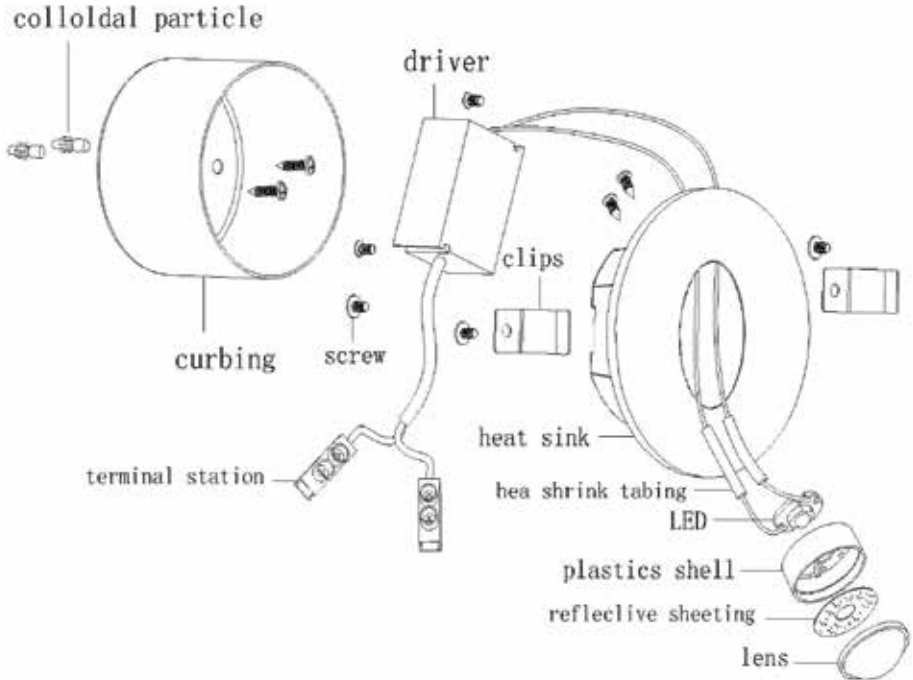

INSTALLATION INSTRUCTIONS

- Switch off the power.
- Cut a hole using an appropriate tool according to cut-out. (Picture 1)
- Fix rubber stopper install the back of the lamp property and using screwy to fix in the hole. (Picture 2)
- Connect the wire of the driver to mains (100-240V) in a correct way (Picture 3)
- Install the lamp property see (Picture 4)
- Switch on the power if the instructions above are done properly with no mistakes.

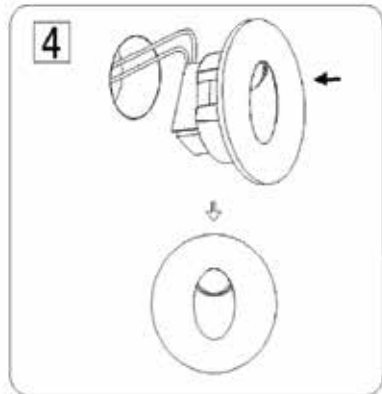
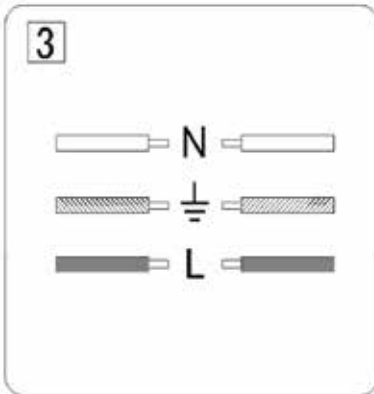
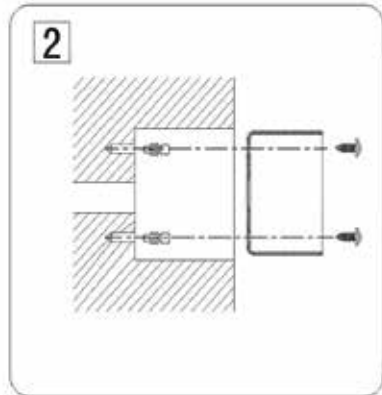
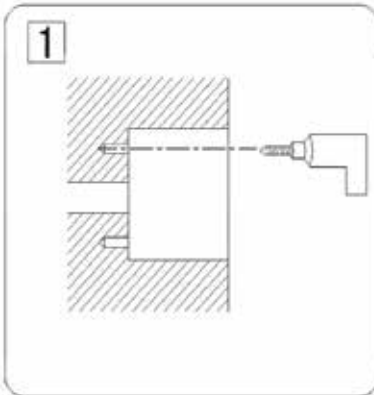

NOTICE

- Risk of shock, hence disconnect at fuse or circuit breaker before installation or servicing.
- Suitable for a Maximum use of 10-12 Hours Daily. Usage of product for 24Hours a day would void the warranty.
- Consult a certified technician if you are unsure.

WARRANTY

- This product is warranty from manufacturing defect only.
- The warranty is valid for 2 years from the date of purchase.
- The warranty does not apply to damage caused by installation or abnormal wear and tear.
- The company gives no warranty against damage to any surface due to incorrect removal and installation of the product.

WARNING

- This is a high-powered LED. As with any light source, direct viewing should be avoided.
- Note: Although easy to fit, this lamp requires wiring to the main and safety should only be fitted by a qualified electrician.
- Having issued this warning, the company accepts no responsibility for issues arising for any failures to comply with these clear instructions.
- The company will not accept any responsibility for any other issues from improper use of fitting of this product as these matters are beyond our control.