



Meaningful Innovation.

WEEE Number: 80133970

INSTRUCTION MANUAL

LED BACKLIT PANEL



02 YEAR
WARRANTY*

SUPER BRIGHT
180+
LM/WATT EFFICIENCY

TECHNICAL DATA

MODEL	VT-60025	LIFE SPAN	20,000 Hours
SKU	23393, 23458	ON/OFF CYCLE	>15,000
SHAPE	SQUARE	OPERATING TEMPERATURE	-10°C to +35°C
WATTS	25W	INPUT VOLTAGE	AC: 220-240V, 50/60Hz
LUMENS	4500 Lm	IP RATING	IP20
BEAM ANGLE	110°	BODY TYPE	PS+AL+SPCC
CRI	≥80	DIMENSION	595x595x33mm
DF	≥0.9		

INTRODUCTION & WARRANTY

Thank you for selecting and buying V-TAC product. V-TAC will serve you the best. Please read these instructions carefully before starting the installation and keep this manual handy for future reference. If you have any other query, please contact our dealer or local vendor from whom you have purchased the product. They are trained and ready to serve you at the best. The warranty is valid for 2 years from the date of purchase. The warranty does not apply to damage caused by incorrect installation or abnormal wear and tear. The company gives no warranty against damage to any surface due to incorrect removal and installation of the product. The products are suitable for 10-12 Hours Daily operation. Usage of product for 24 Hours a day would void the warranty. This product is warranted for manufacturing defects only.



MULTI-LANGUAGE MANUAL QR CODE

Please scan the QR code to access the manual in multiple languages.



FR

Cet appareil, ses accessoires et cordons se recyclent

À DÉPOSER EN MAGASIN



OU



À DÉPOSER EN DÉCHÈTERIE

Points de collecte sur www.quefairedemesdechets.fr
Privilégiez la réparation ou le don de votre appareil !

In case of any query/issue with the product, please reach out to us at: support@v-tac.eu
For More products range, inquiry please contact our distributor or nearest dealers.
V-TAC EUROPE LTD. Bulgaria, Plovdiv 4000, bul.L.Karavelow 9B

WARNING

1. Please make sure to turn off the power before starting the installation.
2. Installation must be performed by a qualified electrician.
3. The light source of this luminaire is not replaceable, when the light source reaches its end of life the whole luminaire should be replaced.
4. If the external flexible cable or cord of this luminaire is damaged, it shall be exclusively replaced by the manufacturer or his service agent or a similar qualified person in order to avoid a hazard.
5. For indoor use only.

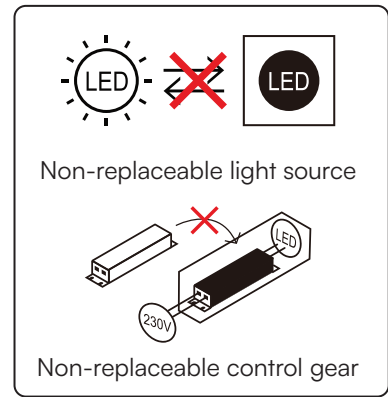

This marking indicates that this product should not be disposed of with other household wastes.



Caution, Risk of electric shock

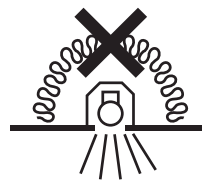

Luminaires not suitable for covering with thermally insulating material.

INSTALLATION INSTRUCTION

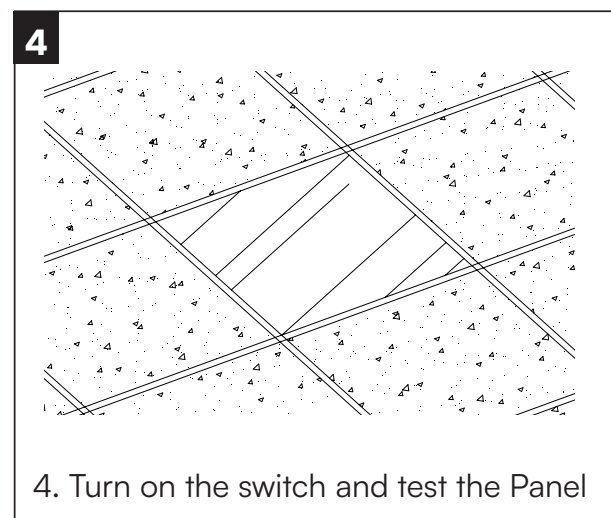
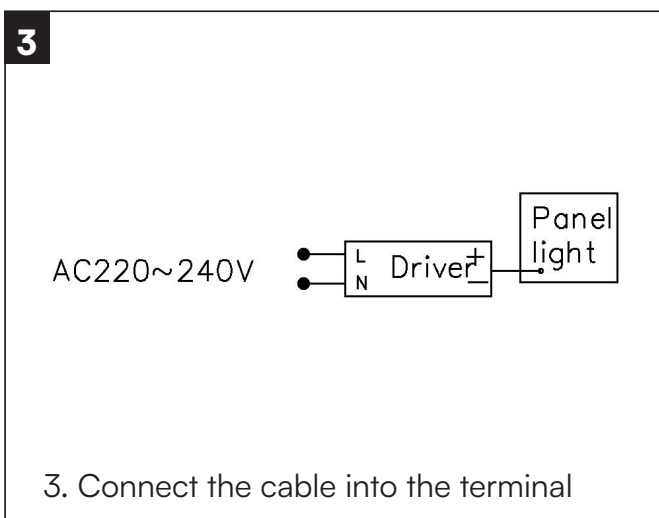
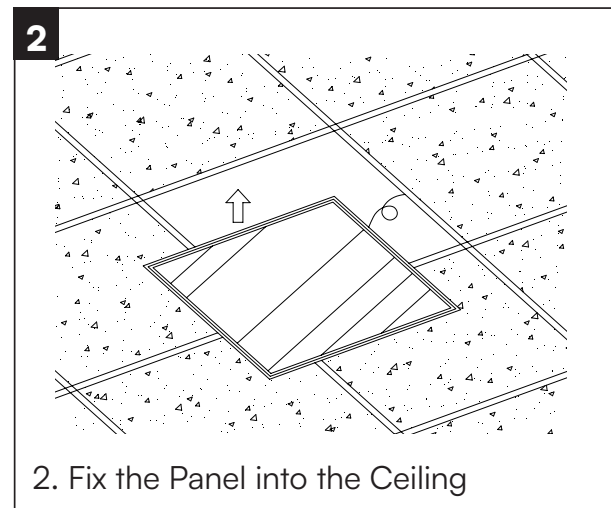
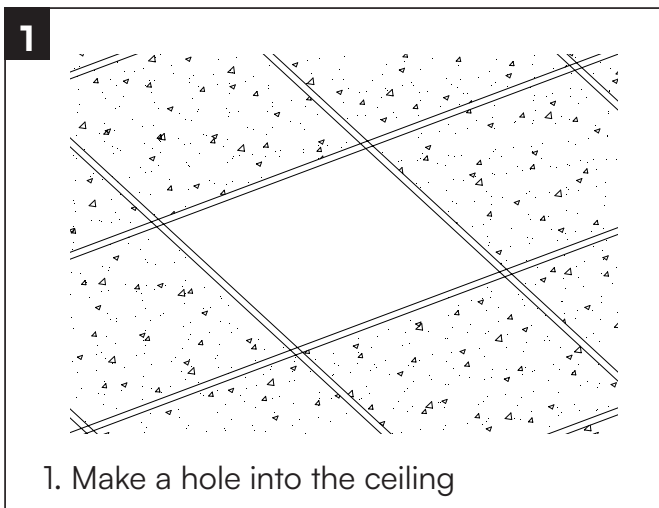

RoHS



UK
CA





Meaningful Innovation.

WEEE Number: 80133970

РЪКОВОДСТВО ЗА УПОТРЕБА

ПАНЕЛ С LED ПОДСВЕТКА

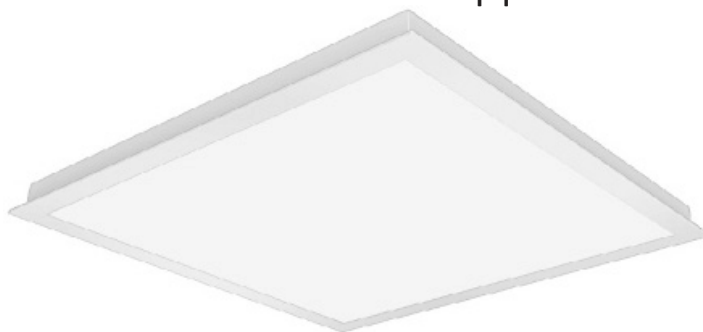

02 YEAR
WARRANTY*

SUPER BRIGHT
180+
LM/WATT EFFICIENCY

ТЕХНИЧЕСКИ ДАННИ

МОДЕЛ	VT-60025	ПРОДЪЛЖИТЕЛНОСТ НА ЖИВОТА	20 000 часа
SKU	23393, 23458	ЦИКЪЛ НА ВКЛЮЧВАНЕ/ИЗКЛЮЧВАНЕ	>15,000
SHAPE	КВАДРАТ	РАБОТНА ТЕМПЕРАТУРА	-10°C до +35°C
WATTS	25W	ВХОДНО НАПРЕЖЕНИЕ	AC: 220-240V, 50/60Hz
LUMENS	4500 Lm	IP РЕЙТИНГ	IP20
ЪГЪЛ НА ЛЪЧА	110°	ТИП НА ТЯЛОТО	PS+AL+SPCC
CRI	≥80	РАЗМЕР	595x595x33 мм
DF	≥0.9		

ВЪВЕДЕНИЕ И ГАРАНЦИЯ

Благодарим ви, че избрахте и закупихте продукт на V-TAC. V-TAC ще ви служи по най-добрия начин. Моля, прочетете внимателно тези инструкции, преди да започнете инсталацията, и пазете това ръководство под ръка за бъдещи справки. Ако имате някакви други въпроси, моля, свържете се с нашия дилър или с местния продавач, от когото сте закупили продукта. Те са обучени и са готови да ви обслужат по най-добрия начин. Гаранцията е валидна за срок от 2 години от датата на закупуване. Гаранцията не важи за повреди, причинени от неправилен монтаж или необичайно износване. Фирмата не дава гаранция за повреди на повърхности, дължащи се на неправилно демонтиране и инсталиране на продукта. Продуктите са подходящи за 10-12-часова ежедневна работа. Използването на продукта в продължение на 24 часа на ден води до отпадане на гаранцията. Този продукт има гаранция само за производствени дефекти.



FR

Cet appareil, ses accessoires et cordons se recyclent

À DÉPOSER EN MAGASIN



À DÉPOSER EN DÉCHÈTERIE



Points de collecte sur www.quefairedemesdechets.fr
Privilégiez la réparation ou le don de votre appareil !

В случай на запитване/проблем с продукта, моля, свържете се с нас на адрес: support@v-tac.eu За повече продукти, запитване, моля, свържете се с нашия дистрибутор или най-близките дилъри.

V-TAC EUROPE LTD. България, Пловдив 4000, бул.Л.Каравелов 9Б

ПРЕДУПРЕЖДЕНИЕ

1. Моля, уверете се, че сте изключили захранването, преди да започнете монтажа.
2. Монтажът трябва да се извърши от квалифициран електротехник.
3. Източникът на светлина на това осветително тяло не може да се заменя, а когато изтече срокът на експлоатация на източника на светлина, трябва да се смени цялото осветително тяло.
4. Ако външният гъвкав кабел или шнур на това осветително тяло е повреден, той трябва да бъде подменен изключително от производителя, неговия сервизен агент или подобно квалифицирано лице, за да се избегне опасност.
5. Само за употреба на закрито.



Тази маркировка показва, че този продукт не трябва да се изхвърля заедно с други битови отпадъци.



Внимание, риск от електрически удар



Несменяем източник на светлина

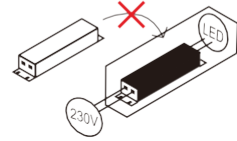

Несменяеми контролни механизми

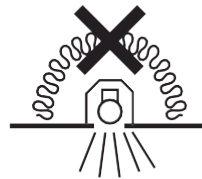

Осветителни тела, които не са подходящи за покриване с теплоизолационен материал.

ИНСТРУКЦИЯ ЗА ИНСТАЛИРАНЕ

1

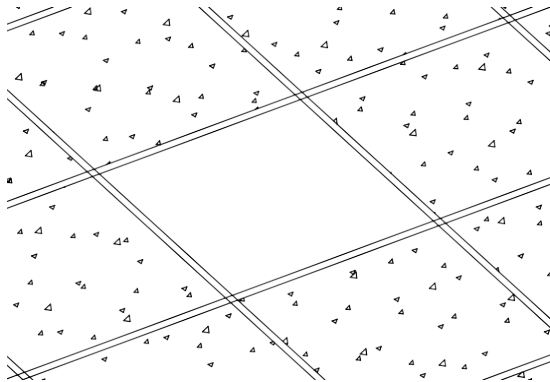

1. Направете отвор в тавана

2

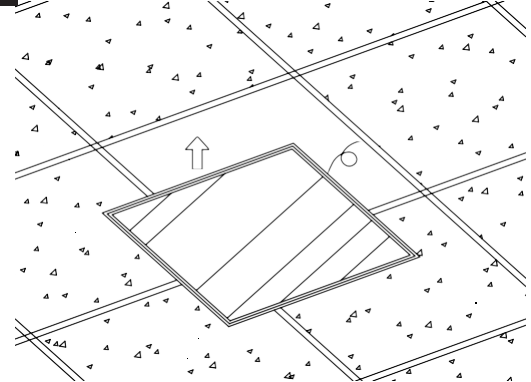

2. Закрепване на панела към тавана

3

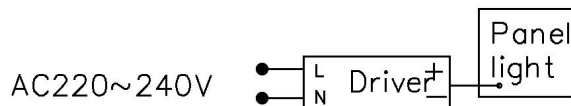

3. Свържете кабела към клемата

4

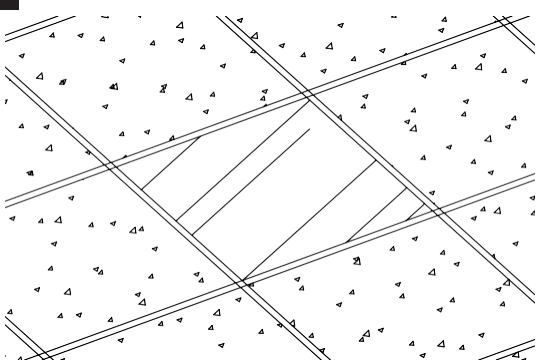

4. Включете превключвателя и тествайте панела

RoHS



UK
CA





Meaningful Innovation.

WEEE Number: 80133970

PRIRUČNIK ZA UPORABU LED POZADINSKI PANEL



02 YEAR
WARRANTY*

SUPER BRIGHT
180+
LM/WATT EFFICIENCY

TEHNIČKI PODACI

MODEL	VT-60025	ŽIVOTNI VIJEK	20,000 Hours
SKU	23393, 23458	CIKLUS UKLJUČIVANJA/ ISKLUČIVANJA	>15,000
OBLIK	SQUARE	RADNA TEMPERATURA	-10°C to +35°C
WATTI	25W	ULAZNI NAPON	AC: 220-240V, 50/60Hz
LUMENI	4500 Lm	IP OCJENA	IP20
KUT ZRAKA	110°	TIP TJELESA	PS+AL+SPCC
CRI	≥80	DIMENZIJA	595x595x33mm
DF	≥0.9		

UVOD & JAMSTVO

Hvala što ste odabrali i kupili V-TAC proizvod. V-TAC će vam poslužiti najbolje. Pažljivo pročitajte ove upute prije početka instalacije i čuvajte ovaj priručnik pri ruci za buduće potrebe. Ako imate bilo kakvih dodatnih pitanja, obratite se našem trgovcu ili lokalnom prodavaču od kojeg ste kupili proizvod. Oni su obučeni i spremni poslužiti vas na najbolji način. Jamstvo vrijedi 2 godine od datuma kupnje. Jamstvo se ne odnosi na oštećenja uzrokovana neispravnom ugradnjom ili nenormalnim trošenjem. Tvrtka ne daje jamstvo protiv oštećenja bilo koje površine uslijed nepravilnog uklanjanja i postavljanja proizvoda. Proizvodi su prikladni za 10-12 sati dnevnog rada. Korištenje proizvoda 24 sata dnevno poništilo bi jamstvo. Ovaj proizvod ima jamstvo samo za greške nastale u proizvodnji.



FR

Cet appareil,
ses accessoires
et cordons
se recyclent

À DÉPOSER
EN MAGASIN



OU

À DÉPOSER
EN DÉCHÈTERIE



Points de collecte sur www.quefairedemesdechets.fr
Privilégiez la réparation ou le don de votre appareil !

U slučaju bilo kakvog upita/problema s proizvodom, obratite nam se na: support@v-tac.eu Za više proizvoda, upite, obratite se našem distributeru ili najbližim trgovcima.
V-TAC EUROPE LTD. Bugarska, Plovdiv 4000, bul.L.Karavelow 9B

UPOZORENJE

1. Provjerite jeste li isključili napajanje prije početka instalacije.
2. Instalaciju mora izvesti kvalificirani električar.
3. Izvor svjetlosti ove svjetiljke nije zamjenjiv, kada izvor svjetlosti dođe do kraja životnog vijeka, cijelu svjetiljku treba zamijeniti.
4. Ako je vanjski savitljivi kabel ili kabel ove svjetiljke oštećen, zamijenit će ga isključivo proizvođač ili njegov serviser ili slična kvalificirana osoba kako bi se izbjegla opasnost.
5. Samo za unutarnju upotrebu.



Ova oznaka označava da se ovaj proizvod ne smije odlagati s ostalim kućnim otpadom.



Oprez, opasnost od strujnog udara

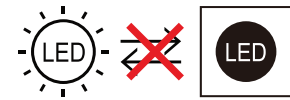

Nezamjenjiv izvor svjetla

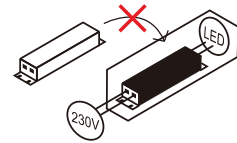

Nezamjenjivi upravljački uređaj

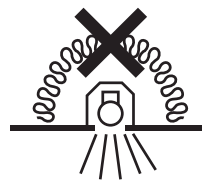

Svjetiljke nisu prikladne za oblaganje toplinski izolacijskim materijalom.

UPUTE ZA MONTAŽU

1

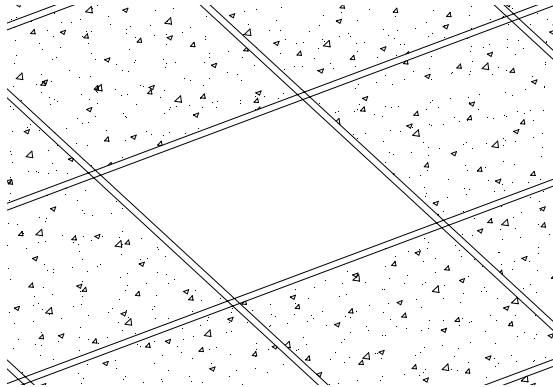

1. Napravite rupu u stropu

2

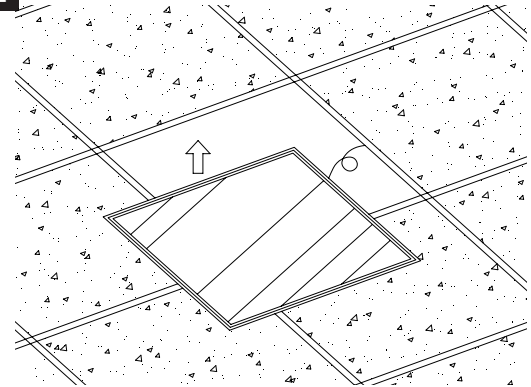

2. Pričvrstite ploču na strop

3

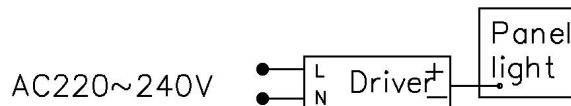

3. Spojite kabel u terminal

4

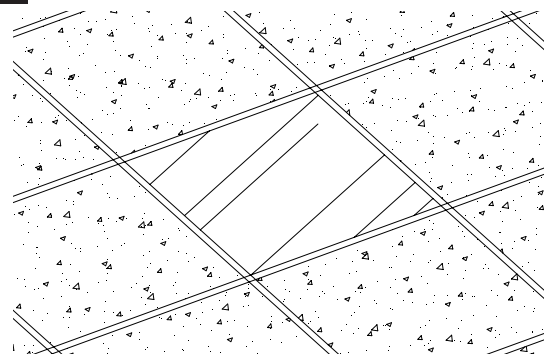

4. Uključite prekidač i testirajte ploču

RoHS



UK
CA





Meaningful Innovation.

WEEE Number: 80133970

NÁVOD K POUŽITÍ

PANEL S LED PODSVÍCENÍM

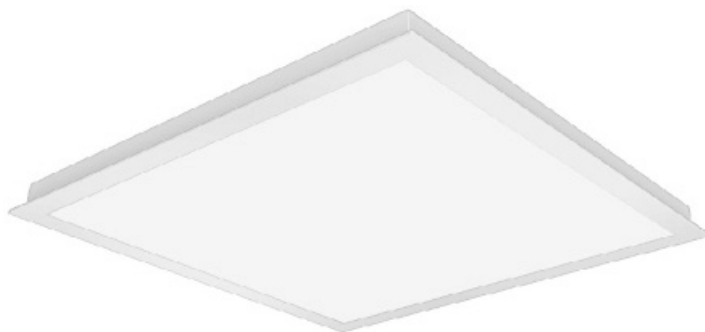

02 YEAR
WARRANTY*

SUPER BRIGHT
180+
LM/WATT EFFICIENCY

TECHNICKÉ ÚDAJE

MODEL	VT-60025	DÉLKA ŽIVOTA	20 000 hodin
SKU	23393, 23458	CYKLUS ZAPNUTÍ/VYPNUTÍ	>15,000
SHAPE	SQUARE	PROVOZNÍ TEPLOTA	-10 °C až +35 °C
WATTS	25W	VSTUPNÍ NAPĚTÍ	AC: 220-240 V, 50/60 Hz
LUMENS	4500 lm	IP RATING	IP20
ÚHEL PAPRSKU	110°	TYP TĚLA	PS+AL+SPCC
CRI	≥80	DIMENSION	595x595x33 mm
DF	≥0.9		

ÚVOD A ZÁRUKA

Děkujeme, že jste si vybrali a zakoupili produkt V-TAC. V-TAC vám bude sloužit co nejlépe. Před zahájením instalace si pozorně přečtěte tento návod a uschovejte jej pro budoucí použití. V případě dalších dotazů se obraťte na našeho prodejce nebo místního prodejce, od kterého jste výrobek zakoupili. Jsou vyškoleni a připraveni vám co nejlépe posloužit. Záruka je platná po dobu 2 let od data zakoupení. Záruka se nevztahuje na poškození způsobené nesprávnou instalací nebo abnormálním opotřebením. Společnost neposkytuje záruku na poškození jakéhokoli povrchu v důsledku nesprávné demontáže a instalace výrobku. Výrobky jsou vhodné pro 10-12 hodin denního provozu. Používání výrobku po dobu 24 hodin denně by znamenalo ztrátu záruky. Na tento výrobek se vztahuje záruka pouze na výrobní vady.



FR

Cet appareil,
ses accessoires
et cordons
se recyclent

À DÉPOSER
EN MAGASIN



À DÉPOSER
EN DÉCHÈTERIE



OU

Points de collecte sur www.quefairedemesdechets.fr
Privilégiez la réparation ou le don de votre appareil !

V případě jakýchkoli dotazů/potíží s produktem se na nás obraťte na adrese: support@v-tac.eu. Pro více informací o sortimentu se prosím obraťte na našeho distributora nebo nejbližšího prodejce.

V-TAC EUROPE LTD. Bulharsko, Plovdiv 4000, bul.L.Karavelow 9B

VAROVÁNÍ

1. Před zahájením instalace nezapomeňte vypnout napájení.
2. Instalaci musí provést kvalifikovaný elektrikář.
3. Světelný zdroj tohoto svítidla není vyměnitelný, po skončení životnosti světelného zdroje je třeba vyměnit celé svítidlo.
4. Pokud dojde k poškození vnějšího ohebného kabelu nebo šňůry tohoto svítidla, musí být vyměněn výhradně výrobcem nebo jeho servisním zástupcem nebo podobně kvalifikovanou osobou, aby se předešlo nebezpečí.
5. Pouze pro vnitřní použití.



Toto označení znamená, že tento výrobek by neměl být likvidován společně s ostatním domovním odpadem.



Pozor, nebezpečí úrazu elektrickým proudem

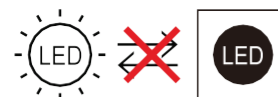

Nevyměnitelný zdroj světla

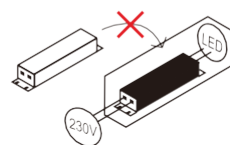

Nevyměnitelné ovládací zařízení



Svítidla nejsou vhodná pro zakrytí tepelně izolačním materiálem.

NÁVOD K INSTALACI

1

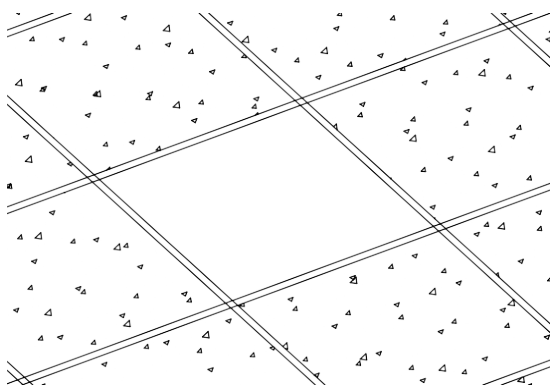

1. Udělejte otvor do stropu

2

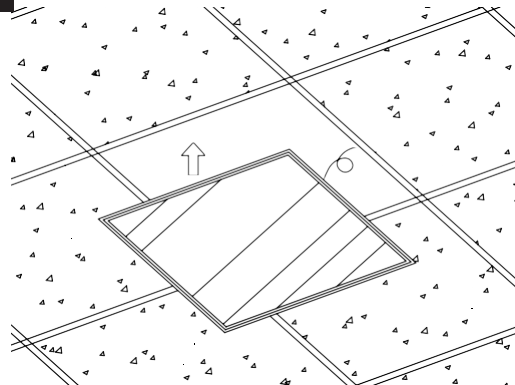

2. Upevnění panelu do stropu

3

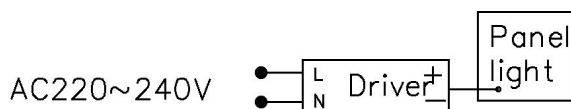

3. Připojte kabel do svorky

4

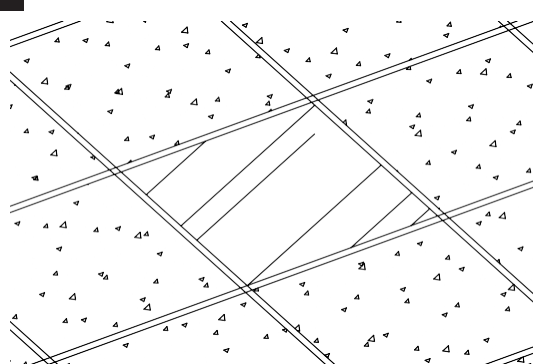

4. Zapněte vypínač a otestujte panel

RoHS



UK
CA





Meaningful Innovation.

WEEE Number: 80133970

MANUEL D'INSTRUCTIONS

PANNEAU RÉTROÉCLAIRÉ À DIODES ÉLECTROLUMINESCENTES

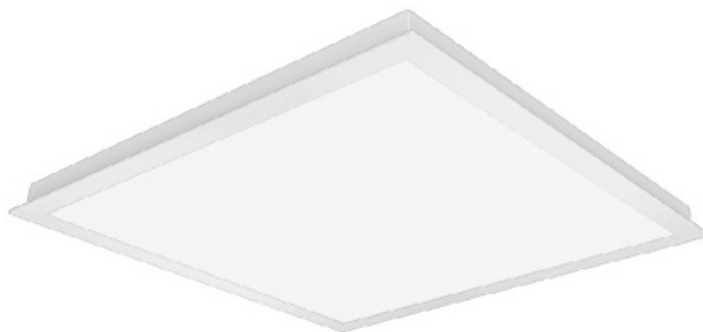

02 YEAR
WARRANTY*

SUPER BRIGHT
180+
LM/WATT EFFICIENCY

DONNÉES TECHNIQUES

MODÈLE	VT-60025	DURÉE DE VIE	20 000 heures
SKU	23393, 23458	CYCLE MARCHÉ/ARRÊT	>15,000
FORME	CARRE	TEMPÉRATURE DE FONCTIONNEMENT	De -10°C à +35°C
WATTS	25W	TENSION D'ENTRÉE	AC : 220-240V, 50/60Hz
LUMENS	4500 Lm	NOTE IP	IP20
ANGLE DU FAISCEAU	110°	TYPE DE CORPS	PS+AL+SPCC
CRI	≥80	DIMENSION	595x595x33mm
DF	≥0.9		

INTRODUCTION ET GARANTIE

Merci d'avoir choisi et acheté un produit V-TAC. V-TAC vous servira au mieux. Veuillez lire attentivement ces instructions avant de commencer l'installation et conservez ce manuel à portée de main pour pouvoir vous y référer ultérieurement. Si vous avez d'autres questions, veuillez contacter notre revendeur ou le vendeur local auprès duquel vous avez acheté le produit. Ils sont formés et prêts à vous servir au mieux. La garantie est valable pendant 2 ans à compter de la date d'achat. La garantie ne s'applique pas aux dommages causés par une installation incorrecte ou une usure anormale. L'entreprise ne garantit pas les dommages causés à toute surface par un démontage et une installation incorrects du produit. Les produits conviennent pour un fonctionnement quotidien de 10 à 12 heures. L'utilisation du produit pendant 24 heures par jour annule la garantie. Ce produit est garanti pour les défauts de fabrication uniquement.



FR

Cet appareil,
ses accessoires
et cordons
se recyclent

À DÉPOSER
EN MAGASIN



À DÉPOSER
EN DÉCHÈTERIE



Points de collecte sur www.quefairedemesdechets.fr
Privilégiez la réparation ou le don de votre appareil !

En cas de question/problemé concernant le produit, veuillez nous contacter à l'adresse suivante : support@v-tac.eu. Pour une gamme de produits plus étendue, veuillez contacter notre distributeur ou les revendeurs les plus proches.
V-TAC EUROPE LTD. Bulgarie, Plovdiv 4000, bul.L.Karavelow 9B

AVERTISSEMENT

1. Veillez à couper l'alimentation électrique avant de commencer l'installation.
2. L'installation doit être effectuée par un électricien qualifié.
3. La source lumineuse de ce luminaire n'est pas remplaçable. Lorsque la source lumineuse atteint sa fin de vie, l'ensemble du luminaire doit être remplacé.
4. Si le câble ou le cordon flexible externe de ce luminaire est endommagé, il doit être remplacé exclusivement par le fabricant ou son agent de service ou une personne qualifiée similaire afin d'éviter tout danger.
5. Pour une utilisation à l'intérieur uniquement.



Ce marquage indique que ce produit ne doit pas être éliminé avec les autres déchets ménagers.



Attention, risque de choc électrique

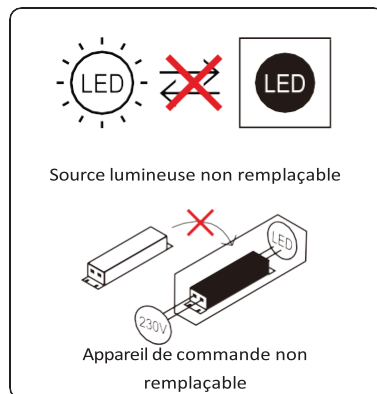

Les luminaires ne conviennent pas pour être recouverts d'un matériau d'isolation thermique.

INSTRUCTIONS D'INSTALLATION

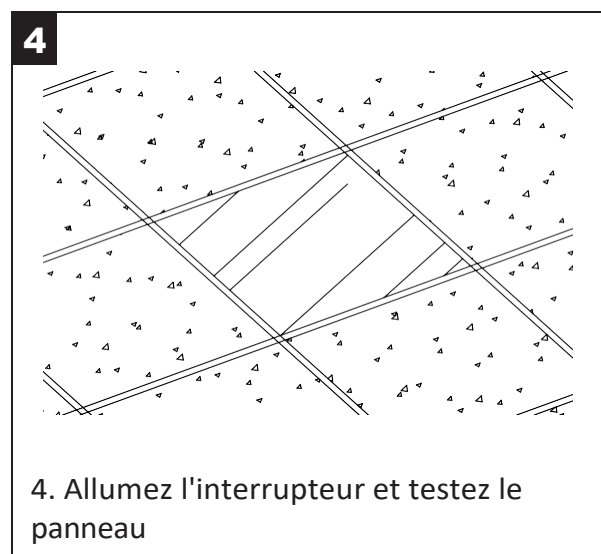
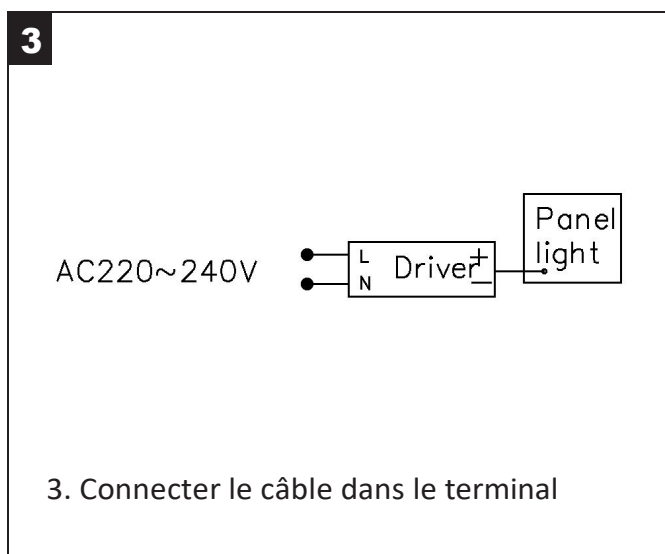
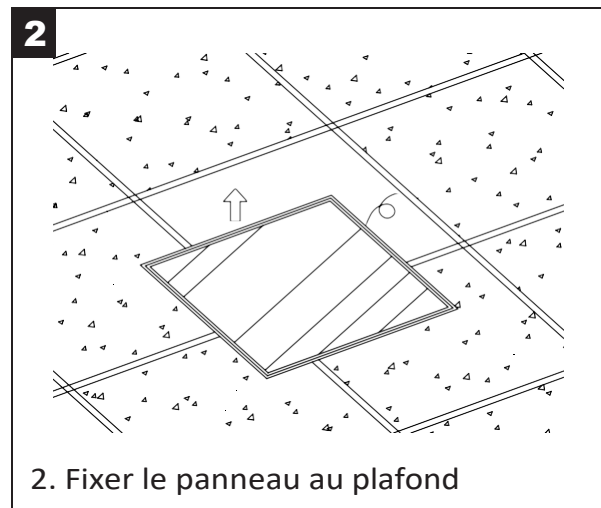
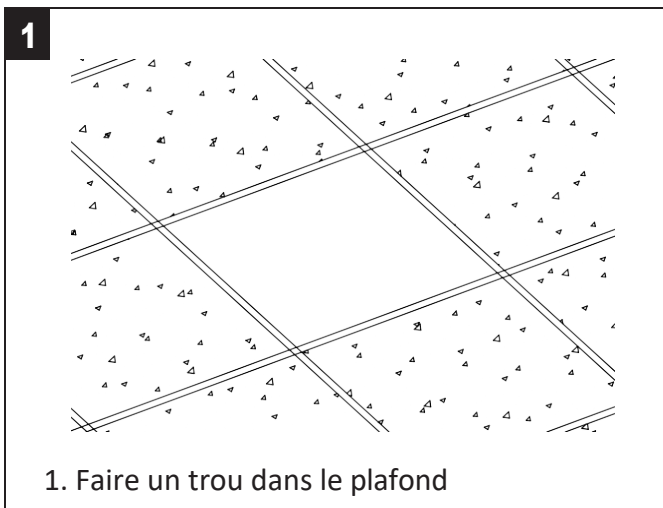

RoHS



UK
CA





Meaningful Innovation.

WEEE Number: 80133970

GEBRAUCHSANWEISUNG

LED-HINTERGRUNDBELEUCHTUNGSPANEL

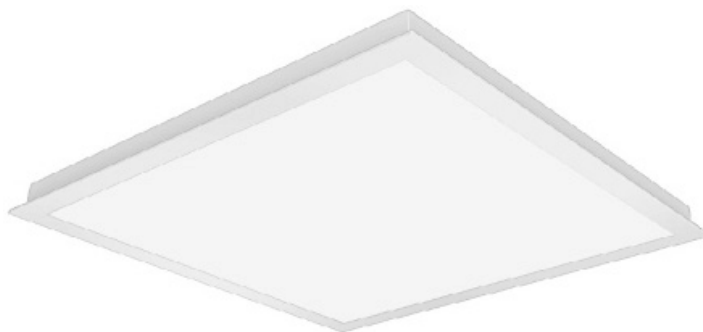

02 YEAR
WARRANTY*

SUPER BRIGHT
180+
LM/WATT EFFICIENCY

TECHNISCHE DATEN

MODELL	VT-60025	LEBENSDAUER	20.000 Stunden
SKU	23393, 23458	EIN/AUS-ZYKLUS	>15,000
SHAPE	SQUARE	BETRIEBSTEMPERATUR	-10°C bis +35°C
WATTS	25W	EINGANGSSPANNUNG	AC: 220-240V, 50/60Hz
LUMENS	4500 Lm	IP RATING	IP20
STRAHLENWINKEL	110°	KÖRPER-TYP	PS+AL+SPCC
CRI	≥80	DIMENSION	595x595x33mm
DF	≥0.9		

EINFÜHRUNG & GARANTIE

Vielen Dank, dass Sie ein V-TAC-Produkt ausgewählt und gekauft haben. V-TAC wird Ihnen die besten Dienste leisten. Bitte lesen Sie diese Anweisungen sorgfältig durch, bevor Sie mit der Installation beginnen, und bewahren Sie diese Anleitung zum späteren Nachschlagen auf. Sollten Sie weitere Fragen haben, wenden Sie sich bitte an unseren Händler oder an den lokalen Verkäufer, von dem Sie das Produkt gekauft haben. Sie sind geschult und bereit, Sie bestmöglich zu bedienen. Die Garantie gilt für 2 Jahre ab dem Kaufdatum. Die Garantie gilt nicht für Schäden, die durch unsachgemäße Installation oder abnormalen Verschleiß verursacht wurden. Das Unternehmen übernimmt keine Garantie für Schäden an Oberflächen, die durch unsachgemäßen Aus- und Einbau des Produkts entstehen. Die Produkte sind für einen täglichen Betrieb von 10-12 Stunden geeignet. Bei einer Nutzung des Produkts über 24 Stunden pro Tag erlischt die Garantie. Für dieses Produkt wird nur eine Garantie für Herstellungsfehler gewährt.



FR

Cet appareil,
ses accessoires
et cordons
se recyclent

À DÉPOSER
EN MAGASIN



OU

À DÉPOSER
EN DÉCHÈTERIE



Points de collecte sur www.quefairedemesdechets.fr
Privilégiez la réparation ou le don de votre appareil !

Bei Fragen/Problemen mit dem Produkt wenden Sie sich bitte an uns: support@v-tac.eu. Für weitere Produkte,
Anfragen kontaktieren Sie bitte unseren Distributor oder den nächsten Händler.
V-TAC EUROPE LTD. Bulgarien, Plovdiv 4000, bul.L.Karavelow 9B

WARNUNG

1. Bitte stellen Sie sicher, dass Sie den Strom abschalten, bevor Sie mit der Installation beginnen.
2. Die Installation muss von einem qualifizierten Elektriker durchgeführt werden.
3. Die Lichtquelle dieser Leuchte ist nicht austauschbar. Wenn die Lichtquelle ihr Lebensende erreicht hat, sollte die gesamte Leuchte ausgetauscht werden.
4. Wenn die äußere flexible Leitung oder das Kabel dieser Leuchte beschädigt ist, muss sie/es ausschließlich durch den Hersteller oder seinen Kundendienst oder eine ähnlich qualifizierte Person ersetzt werden, um eine Gefährdung zu vermeiden.
5. Nur zur Verwendung in Innenräumen.

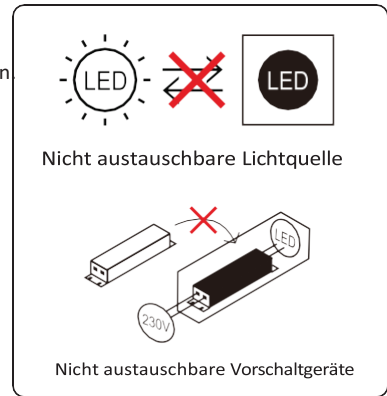

Diese Kennzeichnung weist darauf hin, dass dieses Produkt nicht mit anderen Haushaltsabfällen entsorgt werden darf.



Vorsicht, Gefahr eines elektrischen Schlages



Leuchten, die nicht zur Abdeckung mit wärmeisolierendem Material geeignet sind.

INSTALLATIONSANLEITUNG

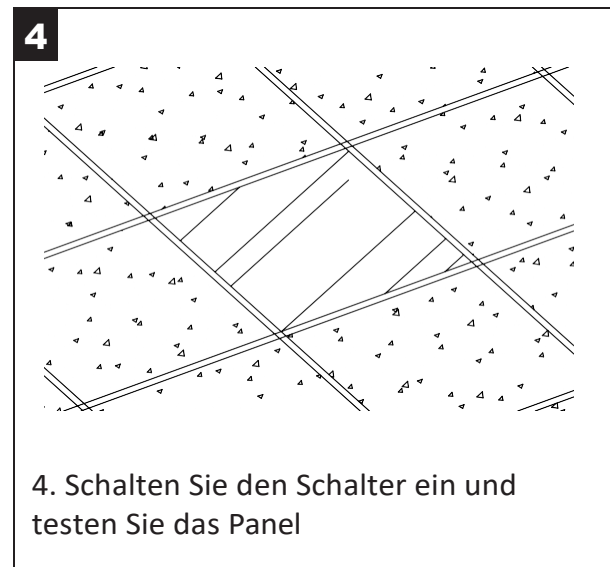
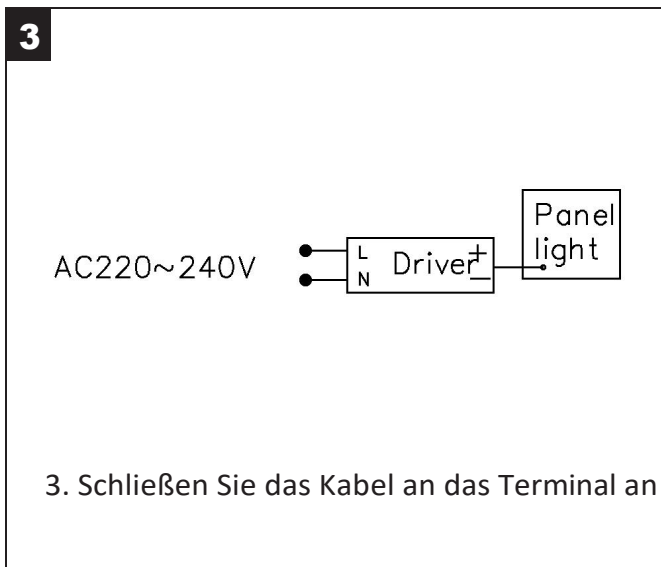
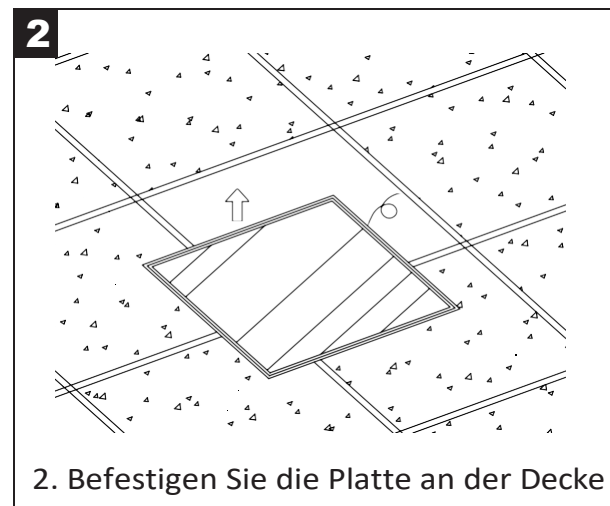
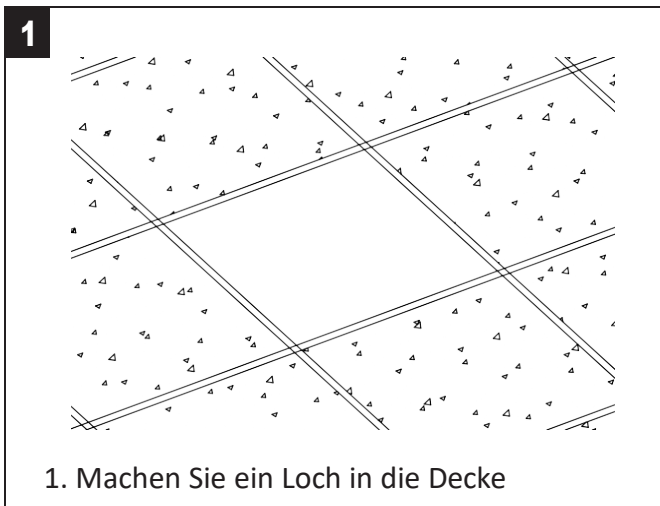

RoHS



UK
CA





Meaningful Innovation.

WEEE Number: 80133970

ΕΓΧΕΙΡΙΔΙΟ ΟΔΗΓΙΩΝ

ΠΑΝΕΛ ΜΕ ΟΠΙΣΘΙΟ ΦΩΤΙΣΜΌ LED

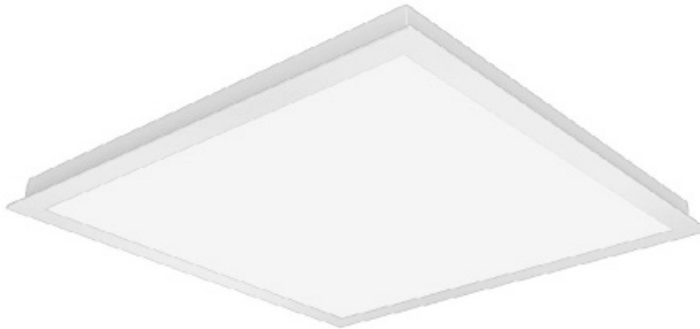

02 YEAR
WARRANTY*

SUPER BRIGHT
180+
LM/WATT EFFICIENCY

ΤΕΧΝΙΚΑ ΣΤΟΙΧΕΙΑ

ΜΟΝΤΕΛΟ	VT-60025	ΔΙΑΡΚΕΙΑ ΖΩΗΣ	20.000 ώρες
SKU	23393, 23458	ΚΥΚΛΟΣ ΕΝΕΡΓΟΠΟΙΗΣΗΣ/ΑΠΕΝΕΡΓΟΠΟΙΗΣΗΣ	>15,000
SHAPE	SQUARE	ΘΕΡΜΟΚΡΑΣΙΑ ΛΕΙΤΟΥΡΓΙΑΣ	-10°C έως +35°C
WATTS	25W	ΤΑΣΗ ΕΙΣΟΔΟΥ	AC: 220-240V, 50/60Hz
LUMENS	4500 Lm	ΒΑΘΜΟΛΟΓΙΑ IP	IP20
ΓΩΝΙΑ ΔΕΞΜΗΣ	110°	ΤΥΠΟΣ ΣΩΜΑΤΟΣ	PS+AL+SPCC
CRI	≥80	ΔΙΑΣΤΑΣΗ	595x595x33mm
DF	≥0.9		

ΕΙΣΑΓΩΓΗ & ΕΓΓΥΗΣΗ

Σας ευχαριστούμε που επιλέξατε και αγοράσατε το προϊόν V-TAC. Η V-TAC θα σας εξυπηρετήσει με τον καλύτερο τρόπο. Παρακαλούμε διαβάστε προσεκτικά αυτές τις οδηγίες πριν ξεκινήσετε την εγκατάσταση και κρατήστε αυτό το εγχειρίδιο πρόχειρο για μελλοντική αναφορά. Εάν έχετε οποιαδήποτε άλλη απορία, παρακαλούμε επικοινωνήστε με τον αντιπρόσωπο μας ή τον τοπικό πωλητή από τον οποίο αγοράσατε το προϊόν. Είναι εκπαιδευμένοι και έτοιμοι να σας εξυπηρετήσουν με τον καλύτερο τρόπο. Η εγγύηση ισχύει για 2 χρόνια από την ημερομηνία αγοράς. Η εγγύηση δεν ισχύει για ζημιές που προκαλούνται από λανθασμένη εγκατάσταση ή μη φυσιολογική φθορά. Η εταιρεία δεν παρέχει καμία εγγύηση για ζημιές σε οποιαδήποτε επιφάνεια λόγω λανθασμένης αφαίρεσης και εγκατάστασης του προϊόντος. Τα προϊόντα είναι κατάλληλα για 10-12 ώρες καθημερινής λειτουργίας. Η χρήση του προϊόντος για 24 ώρες την ημέρα θα ακυρώσει την εγγύηση. Αυτό το προϊόν φέρει εγγύηση μόνο για κατασκευαστικά ελαττώματα.



FR

Cet appareil,
ses accessoires
et cordons
se recyclent

À DÉPOSER
EN MAGASIN



À DÉPOSER
EN DÉCHÈTERIE



OU

Points de collecte sur www.quefairedemesdechets.fr
Privilégiez la réparation ou le don de votre appareil !

Σε περίπτωση οποιουδήποτε ερωτήματος/θέματος με το προϊόν, παρακαλούμε επικοινωνήστε μαζί μας στο: support@v-tac.eu. Για περισσότερες πληροφορίες σχετικά με τη γκάμα των προϊόντων, παρακαλούμε επικοινωνήστε με τον διανομέα μας ή τους πλησιέστερους αντιπροσώπους μας.

V-TAC EUROPE LTD. Βουλγαρία, Φιλιππούπολη 4000, bul.L.Karavelow 9B

ΠΡΟΕΙΔΟΠΟΙΗΣΗ

1. Βεβαιωθείτε ότι έχετε απενεργοποιήσει το ρεύμα πριν ξεκινήσετε την εγκατάσταση.
2. Η εγκατάσταση πρέπει να γίνεται από εξειδικευμένο ηλεκτρολόγο.
3. Η φωτεινή πηγή αυτού του φωτιστικού δεν μπορεί να αντικατασταθεί, όταν η φωτεινή πηγή φτάσει στο τέλος της ζωής της, θα πρέπει να αντικατασταθεί ολόκληρο το φωτιστικό.
4. Εάν το εξωτερικό εύκαμπτο καλώδιο ή το καλώδιο αυτού του φωτιστικού έχει υποστεί ζημιά, πρέπει να αντικαθίσταται αποκλειστικά από τον κατασκευαστή ή τον αντιπρόσωπο σέρβις του ή από παρόμοιο ειδικευμένο άτομο, προκειμένου να αποφευχθεί κίνδυνος.
5. Μόνο για εσωτερική χρήση.

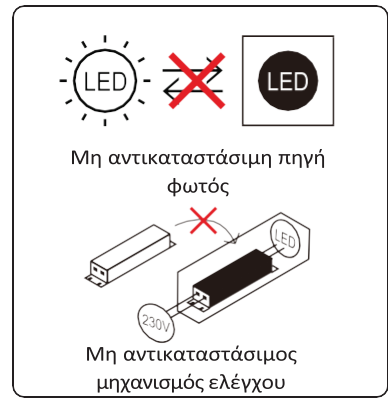

Η σήμανση αυτή υποδεικνύει ότι το προϊόν αυτό δεν πρέπει να απορρίπτεται μαζί με άλλα οικιακά απόβλητα.



Προσοχή, Κίνδυνος ηλεκτροπληξίας

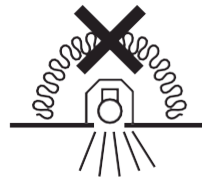

Φωτιστικά σώματα ακατάλληλα για κάλυψη με θερμομονωτικό υλικό.

ΟΔΗΓΙΕΣ ΕΓΚΑΤΑΣΤΑΣΗΣ

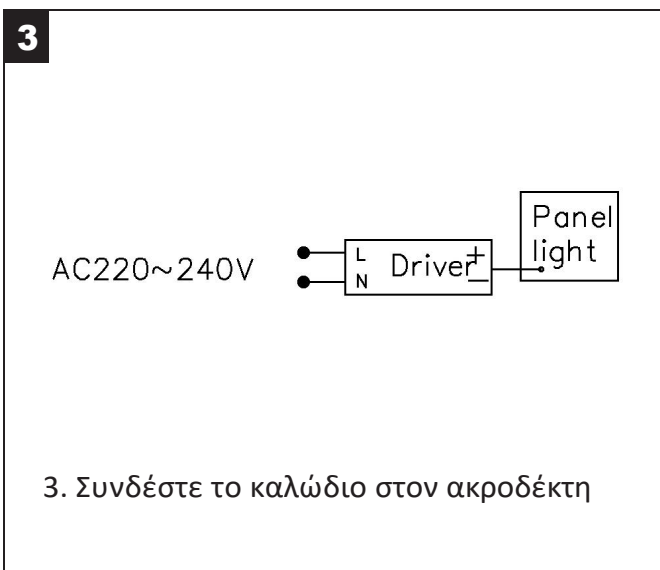
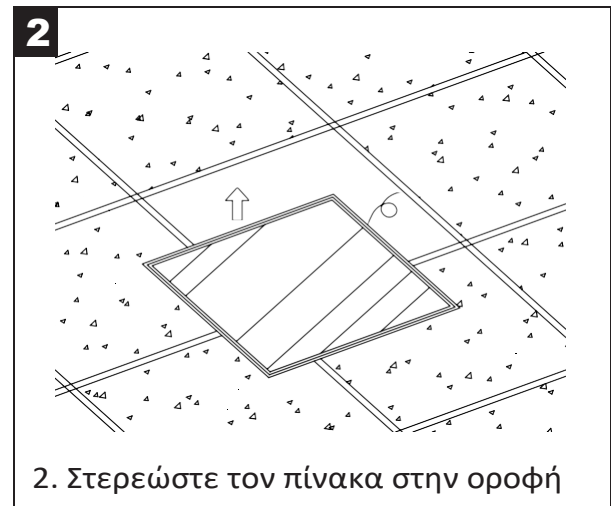
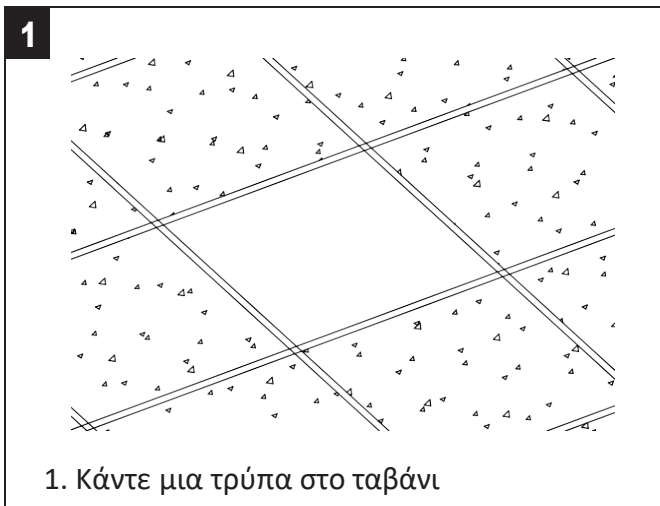

RoHS



UK
CA





Meaningful Innovation.

WEEE Number: 80133970

HASZNÁLATI ÚTMUTATÓ LED HÁTTÉRVILÁGÍTÁSÚ PANEL

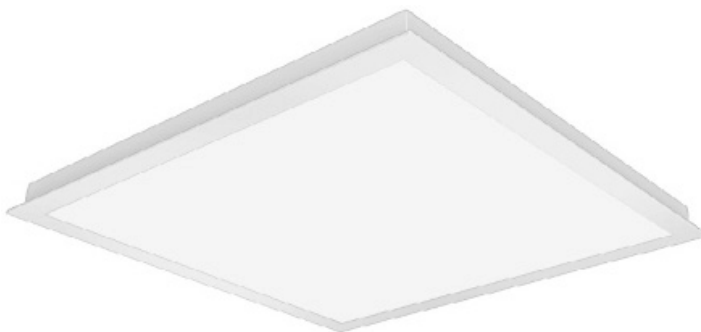

02 YEAR
WARRANTY*

SUPER BRIGHT
180+
LM/WATT EFFICIENCY

TECHNIKAI ADATOK

MODELL	VT-60025	ÉLETSZAKASZ	20,000 óra
SKU	23393, 23458	BE/KIKAPCSOLÁSI CIKLUS	>15,000
SHAPE	SQUARE	ÜZEMI HŐMÉRSÉKLET	-10°C és +35°C között
WATTS	25W	BEMENETI FESZÜLTÉSÉG	AC: 220-240V, 50/60Hz
LUMENS	4500 Lm	IP RATING	IP20
SUGÁR SZÖGE	110°	TESTTÍPUS	PS+AL+SPCC
CRI	≥80	DIMENZIÓ	595x595x33mm
DF	≥0.9		

BEVEZETÉS ÉS GARANCIA

Köszönjük, hogy V-TAC terméket választott és vásárolt. A V-TAC a legjobbat fogja nyújtani Önnek. Kérjük, olvassa el figyelmesen ezeket az utasításokat, mielőtt elkezdi a telepítést, és tartsa kéznél ezt a kézikönyvet a későbbi használatra. Ha bármilyen más kérdése van, kérjük, forduljon a kereskedőnkhez vagy a helyi forgalmazóhoz, akitől a terméket vásárolta. Ők képzettek és készen állnak arra, hogy a lehető legjobban kiszolgálják Önt. A garancia a vásárlástól számított 2 évig érvényes. A garancia nem vonatkozik a helytelen telepítés vagy rendellenes elhasználódás okozta károkra. A vállalat nem vállal garanciát a termék helytelen eltávolítása és beszerelése miatt bármely felületen keletkezett károkra. A termékek napi 10-12 órás működésre alkalmasak. A termék napi 24 órás használata esetén a garancia érvényét veszti. A termékre kizárólag gyártási hibák esetén vállalunk garanciát.



FR

Cet appareil,
ses accessoires
et cordons
se recyclent

À DÉPOSER
EN MAGASIN



À DÉPOSER
EN DÉCHÈTERIE



Points de collecte sur www.quefairedemesdechets.fr
Privilégiez la réparation ou le don de votre appareil !

A termékkel kapcsolatos bármilyen kérdés/probléma esetén kérjük, forduljon hozzánk a következő címen: support@v-tac.eu További termékválasztékért, érdeklődésért kérjük, forduljon forgalmazónkhoz vagy legközelebbi kereskedőnkhez.

V-TAC EUROPE LTD. Bulgária, Plovdiv 4000, bul.L.Karavelow 9B

FIGYELMEZTETÉS

1. A telepítés megkezdése előtt feltétlenül kapcsolja ki a készüléket.
2. A beszerelést szakképzett villanszerelőnek kell elvégeznie.
3. A lámpatest fényforrása nem cserélhető, ha a fényforrás eléri élettartama végét, az egész lámpatestet ki kell cserélni.
4. Ha a lámpatest külső hajlékony kábele vagy zsinórja megsérül, azt a veszély elkerülése érdekében kizárólag a gyártónak vagy szervízének, illetve hasonló képesítéssel rendelkező személynek kell kicserélnie.
5. Csak beltéri használatra.

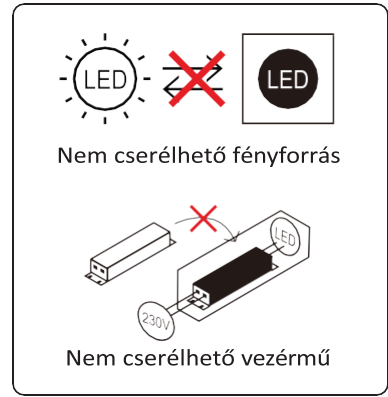

Ez a jelölés azt jelzi, hogy ez a termék nem ártalmatlanítható más háztartási hulladékkal együtt.



Vigyázat, áramütés veszélye



A lámpatestek nem alkalmasak hőszigetelő anyaggal való borításra.

TELEPÍTÉSI UTASÍTÁS

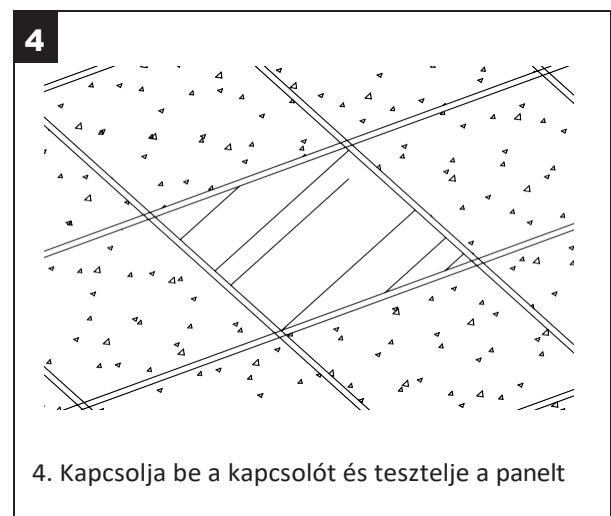
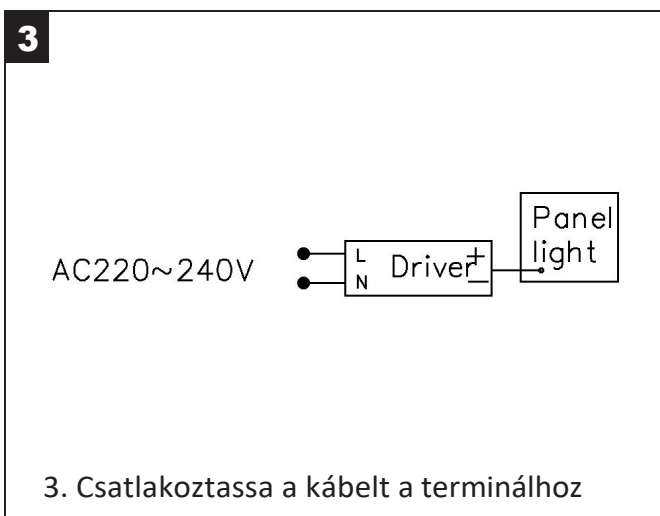
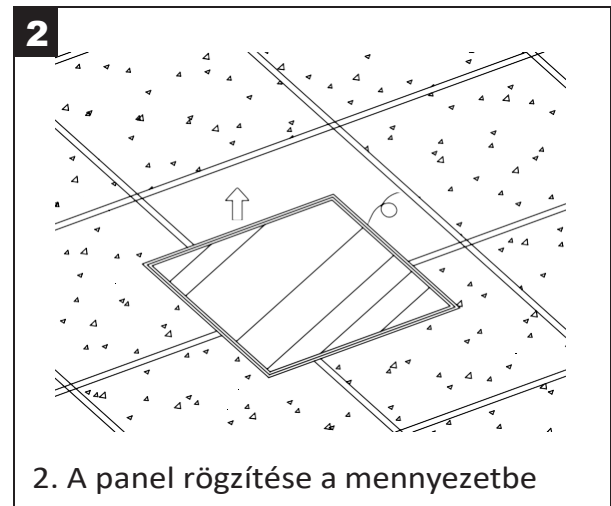
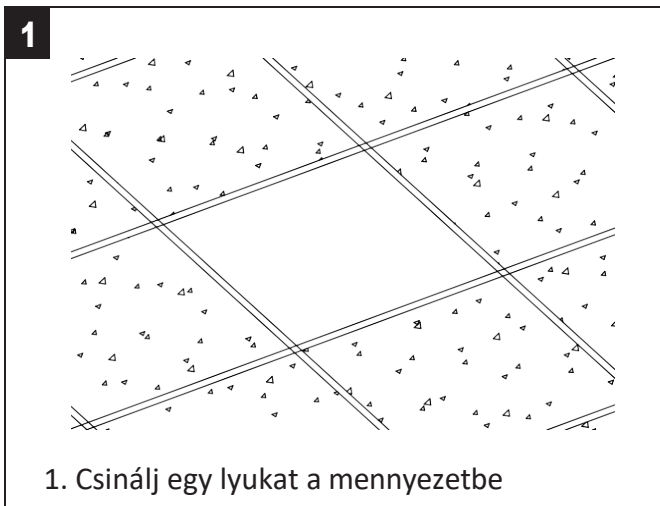

RoHS



UK
CA





Meaningful Innovation.

WEEE Number: 80133970

MANUALE DI ISTRUZIONI

PANNELLO RETROILLUMINATO A LED

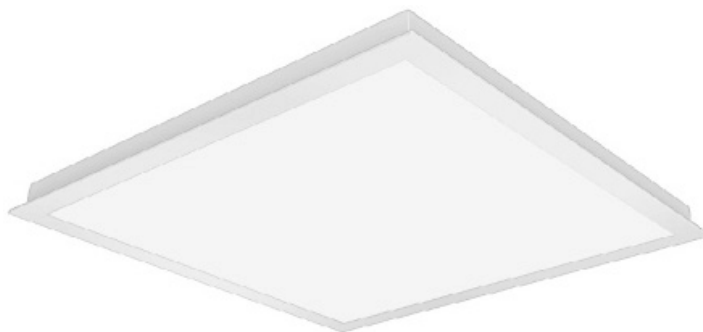

02 YEAR
WARRANTY*

SUPER BRIGHT
180+
LM/WATT EFFICIENCY

DATI TECNICI

MODELLO	VT-60025	DURATA DELLA VITA	20.000 ore
SKU	23393, 23458	CICLO ON/OFF	>15,000
FORMA	PIAZZA	TEMPERATURA DI ESERCIZIO	Da -10°C a +35°C
WATTS	25W	TENSIONE D'INGRESSO	CA: 220-240V, 50/60Hz
LUMENS	4500 Lm	VALUTAZIONE IP	IP20
ANGOLO DEL RAGGIO	110°	TIPO DI CORPO	PS+AL+SPCC
CRI	≥80	DIMENSIONE	595x595x33 mm
DF	≥0.9		

INTRODUZIONE E GARANZIA

Grazie per aver scelto e acquistato un prodotto V-TAC. V-TAC vi servirà al meglio. Si prega di leggere attentamente le presenti istruzioni prima di iniziare l'installazione e di tenere il manuale a portata di mano per future consultazioni. Per qualsiasi altra domanda, contattare il nostro rivenditore o il venditore locale presso il quale è stato acquistato il prodotto. Sono addestrati e pronti a servirvi al meglio. La garanzia è valida per 2 anni dalla data di acquisto. La garanzia non si applica ai danni causati da un'installazione non corretta o da un'usura anomala. L'azienda non fornisce alcuna garanzia contro i danni a qualsiasi superficie dovuti a un'errata rimozione e installazione del prodotto. I prodotti sono adatti per un funzionamento di 10-12 ore al giorno. L'utilizzo del prodotto per 24 ore al giorno invalida la garanzia. Questo prodotto è garantito solo per i difetti di fabbricazione.



FR

Cet appareil,
ses accessoires
et cordons
se recyclent

À DÉPOSER
EN MAGASIN



OU



Points de collecte sur www.quefairedemesdechets.fr
Privilégiez la réparation ou le don de votre appareil !

Per qualsiasi domanda o problema relativo al prodotto, contattateci all'indirizzo: support@v-tac.eu. Per ulteriori informazioni sulla gamma di prodotti, contattate il nostro distributore o i rivenditori più vicini.

V-TAC EUROPE LTD. Bulgaria, Plovdiv 4000, bul.L.Karavelow 9B

ATTENZIONE

1. Assicurarsi di spegnere l'alimentazione prima di iniziare l'installazione.
2. L'installazione deve essere eseguita da un elettricista qualificato.
3. La sorgente luminosa di questo apparecchio non è sostituibile; quando la sorgente luminosa raggiunge la fine del suo ciclo di vita, l'intero apparecchio deve essere sostituito.
4. Se il cavo flessibile esterno o il cavo di questo apparecchio è danneggiato, deve essere sostituito esclusivamente dal produttore o dal suo agente di assistenza o da una persona qualificata simile, al fine di evitare un pericolo.
5. Solo per uso interno.

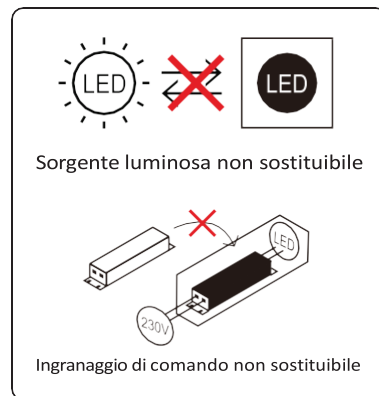

Questo marchio indica che questo prodotto non deve essere smaltito con altri rifiuti domestici.



Attenzione, rischio di scosse elettriche



Apparecchi non adatti a essere coperti con materiale termoisolante.

ISTRUZIONI PER L'INSTALLAZIONE

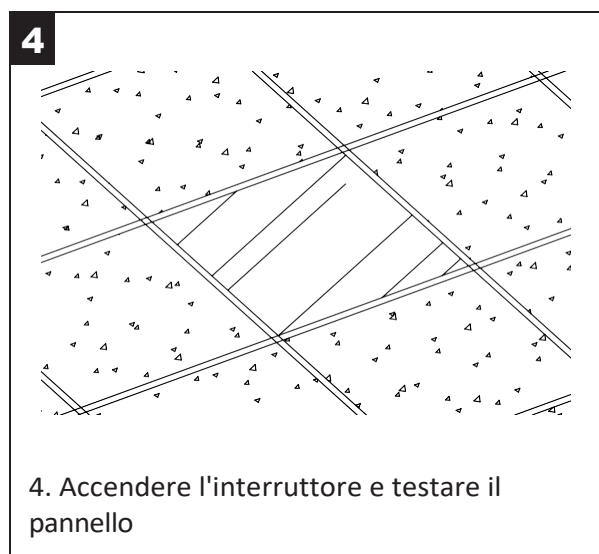
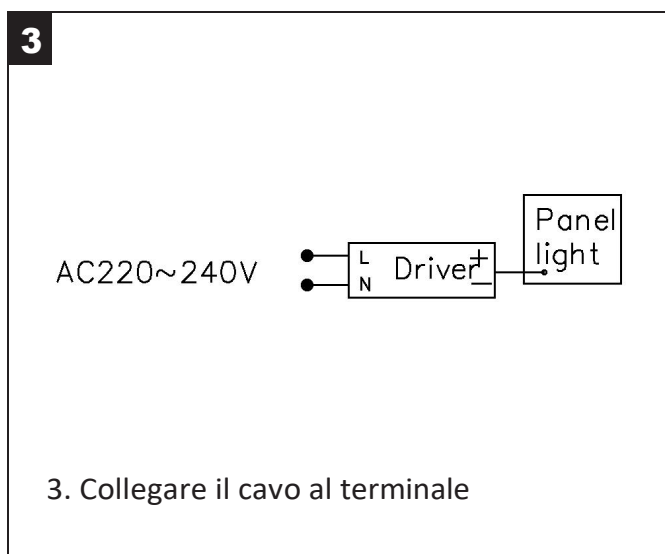
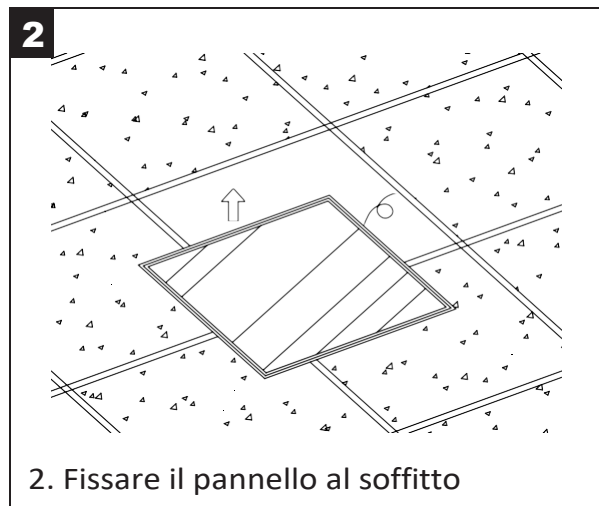
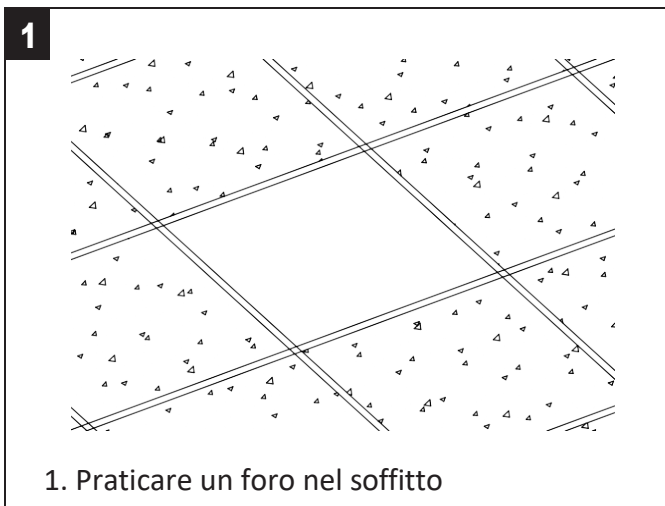

RoHS



UK
CA



INSTRUKCJA OBSŁUGI

PODŚWIETLANY PANEL LED

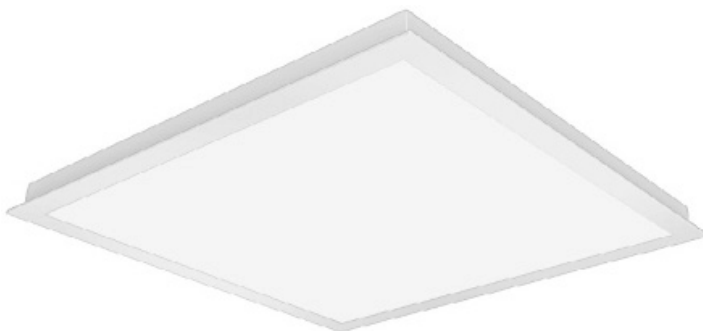

02 YEAR
WARRANTY*

SUPER BRIGHT
180+
LM/WATT EFFICIENCY

DANE TECHNICZNE

MODEL	VT-60025	ROZPIĘTOŚĆ ŻYCIA	20 000 godzin
SKU	23393, 23458	CYKL WŁĄCZANIA/WYŁĄCZANIA	>15,000
KSZTAŁT	KWADRAT	TEMPERATURA PRACY	-10°C do +35°C
WATTS	25W	NAPIĘCIE WEJŚCIOWE	AC: 220-240 V, 50/60 Hz
LUMENY	4500 lm	IP RATING	IP20
KĄT WIĄZKI	110°	TYP NADWOZIA	PS+AL+SPCC
CRI	≥80	WYMIAR	595x595x33mm
DF	≥0.9		

WPROWADZENIE I GWARANCJA

Dziękujemy za wybranie i zakup produktu V-TAC. V-TAC będzie służył jak najlepiej. Przed rozpoczęciem instalacji należy uważnie przeczytać niniejszą instrukcję i zachować ją do wykorzystania w przyszłości. W przypadku jakichkolwiek innych pytań prosimy o kontakt z naszym dealerem lub lokalnym sprzedawcą, od którego zakupiono produkt. Są oni przeszkoleni i gotowi do świadczenia usług na najwyższym poziomie. Gwarancja jest ważna przez 2 lata od daty zakupu. Gwarancja nie obejmuje uszkodzeń spowodowanych nieprawidłową instalacją lub nadmiernym zużyciem. Firma nie udziela gwarancji na uszkodzenia powierzchni spowodowane nieprawidłowym demontażem i montażem produktu. Produkty są odpowiednie do pracy przez 10-12 godzin dziennie. Używanie produktu przez 24 godziny na dobę spowoduje utratę gwarancji. Ten produkt jest objęty gwarancją wyłącznie na wady produkcyjne.



OSTRZEŻENIE

1. Przed rozpoczęciem instalacji należy wyłączyć zasilanie.
2. Instalacja musi zostać przeprowadzona przez wykwalifikowanego elektryka.
3. Źródło światła tej oprawy nie jest wymienne, gdy źródło światła osiągnie koniec okresu eksploatacji, należy wymienić całą oprawę.
4. Jeśli zewnętrzny elastyczny kabel lub przewód tej oprawy oświetleniowej jest uszkodzony, powinien zostać wymieniony wyłącznie przez producenta lub jego przedstawiciela serwisowego lub podobną wykwalifikowaną osobę w celu uniknięcia zagrożenia.
5. Tylko do użytku wewnątrz pomieszczeń.
- 6.



To oznaczenie wskazuje, że tego produktu nie należy wyrzucać razem z innymi odpadami domowymi.



Uwaga, ryzyko porażenia prądem elektrycznym



Niewymienne źródło światła

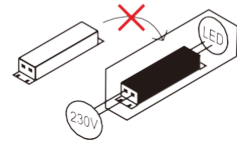

Niewymienne urządzenie

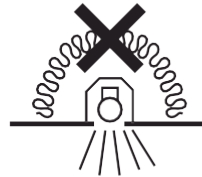

Oprawy nie nadają się do pokrycia materiałem termoizolacyjnym.

INSTRUKCJA INSTALACJI

1

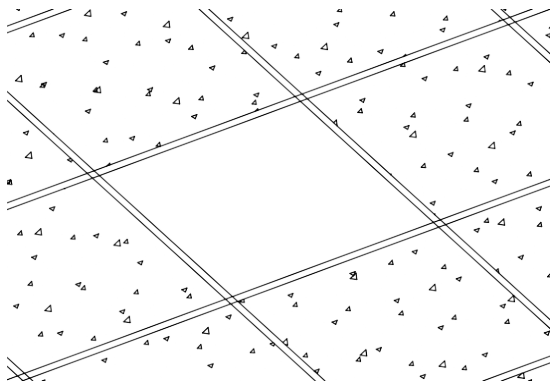

1. Zrób otwór w suficie

2

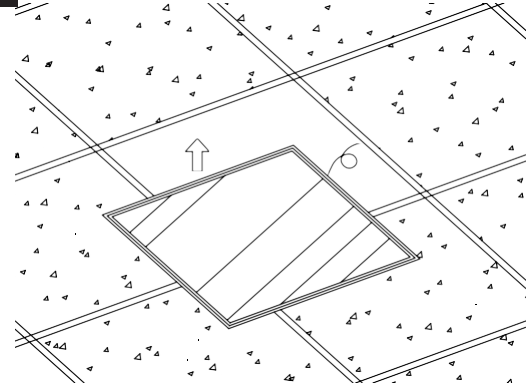

2. Zamocuj panel do sufitu

3

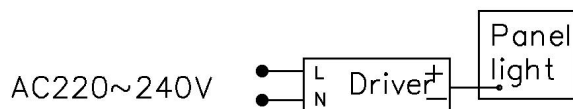

3. Podłącz kabel do terminala

4

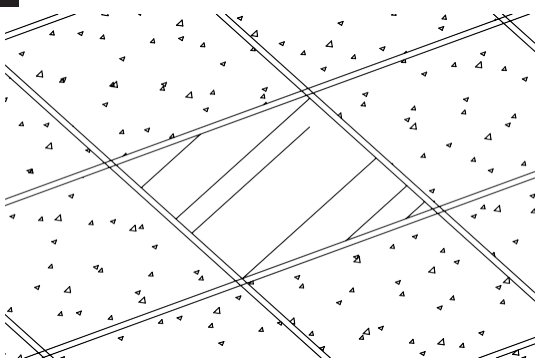

4. Włącz przełącznik i przetestuj panel

RoHS



UK
CA





Meaningful Innovation.

WEEE Number: 80133970

MANUAL DE INSTRUÇÕES

PAINEL RETROILUMINADO POR LED

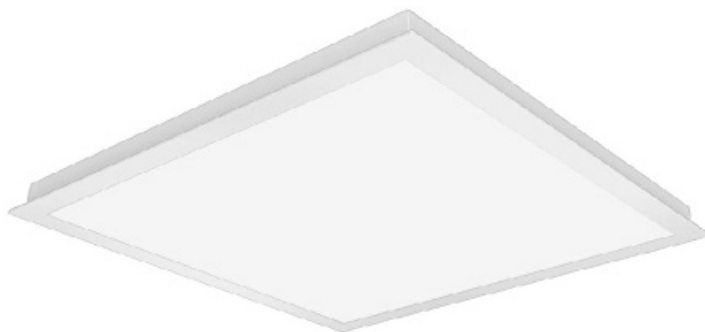

02 YEAR
WARRANTY*

SUPER BRIGHT
180+
LM/WATT EFFICIENCY

DADOS TÉCNICOS

MODELO	VT-60025	DURAÇÃO DA VIDA	20.000 horas
SKU	23393, 23458	CICLO ON/OFF	>15,000
FORMA	QUADRADO	TEMPERATURA DE FUNCIONAMENTO	-10°C a +35°C
ÁGUAS	25W	TENSÃO DE ENTRADA	AC: 220-240V, 50/60Hz
LUMENS	4500 Lm	CLASSIFICAÇÃO IP	IP20
ÂNGULO DO FEIXE	110°	TIPO DE CORPO	PS+AL+SPCC
IRC	≥80	DIMENSÃO	595x595x33mm
DF	≥0.9		

INTRODUÇÃO E GARANTIA

Obrigado por selecionar e comprar o produto V-TAC. A V-TAC irá servi-lo da melhor forma. Por favor, leia atentamente estas instruções antes de iniciar a instalação e mantenha este manual à mão para referência futura. Se tiver qualquer outra dúvida, contacte o nosso revendedor ou o vendedor local a quem adquiriu o produto. Eles têm formação e estão prontos para o servir da melhor forma. A garantia é válida por 2 anos a partir da data de compra. A garantia não se aplica a danos causados por instalação incorrecta ou desgaste anormal. A empresa não dá qualquer garantia contra danos em qualquer superfície devido à remoção e instalação incorrectas do produto. Os produtos são adequados para um funcionamento diário de 10-12 horas. A utilização do produto durante 24 horas por dia anularia a garantia. Este produto tem garantia apenas para defeitos de fabrico.



FR

Cet appareil,
ses accessoires
et cordons
se recyclent

À DÉPOSER
EN MAGASIN



OU

À DÉPOSER
EN DÉCHÈTERIE



Points de collecte sur www.quefairedemesdechets.fr
Privilégiez la réparation ou le don de votre appareil !

Em caso de dúvidas ou problemas com o produto, contacte-nos em: support@v-tac.eu Para mais informações sobre a gama de produtos, contacte o nosso distribuidor ou os revendedores mais próximos.

V-TAC EUROPE LTD. Bulgária, Plovdiv 4000, bul.L.Karavelow 9B

AVISO

1. Certifique-se de que desliga a alimentação eléctrica antes de iniciar a instalação.
2. A instalação deve ser efectuada por um electricista qualificado.
3. A fonte de luz desta luminária não é substituível, quando a fonte de luz atinge o fim da sua vida útil, toda a luminária deve ser substituída.
4. Se o cabo ou o cordão flexível externo dessa luminária estiver danificado, deve ser substituído exclusivamente pelo fabricante ou pelo seu agente de assistência ou por uma pessoa qualificada semelhante, de modo a evitar qualquer perigo.
5. Apenas para utilização em interiores.

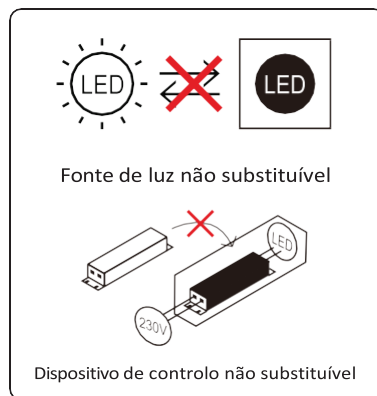

Esta marcação indica que este produto não deve ser eliminado juntamente com outros resíduos domésticos.



Cuidado, risco de choque elétrico



As luminárias não são adequadas para serem cobertas com material de isolamento térmico.

INSTRUÇÕES DE INSTALAÇÃO

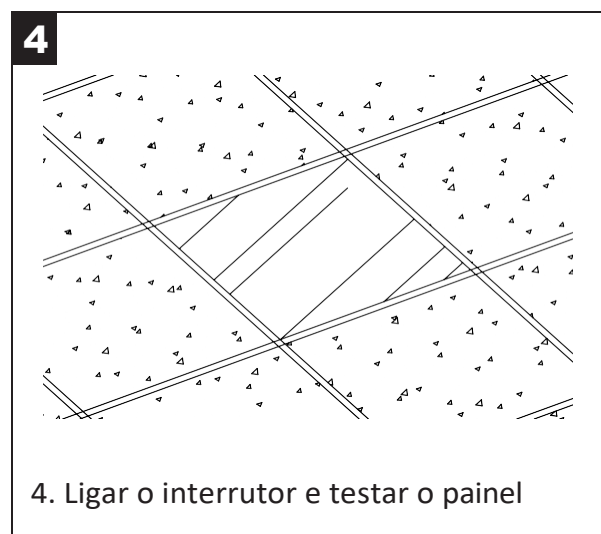
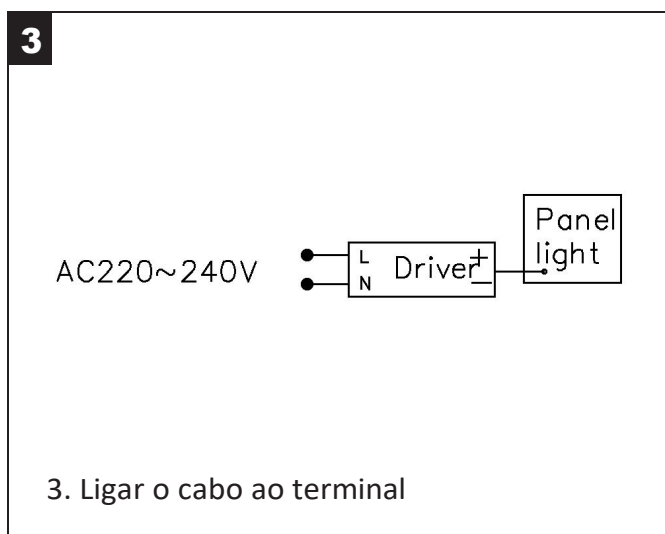
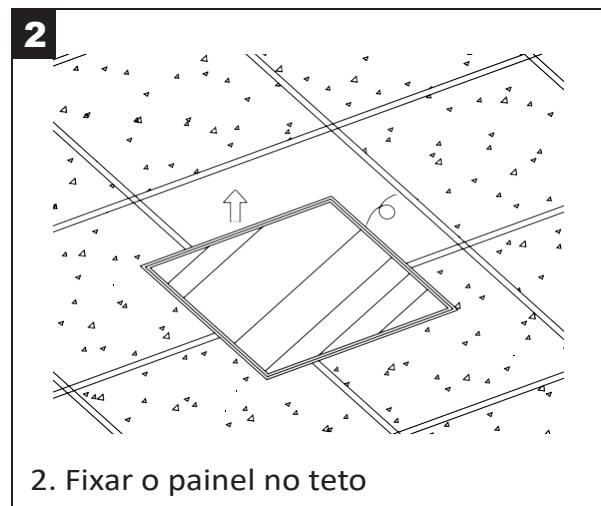
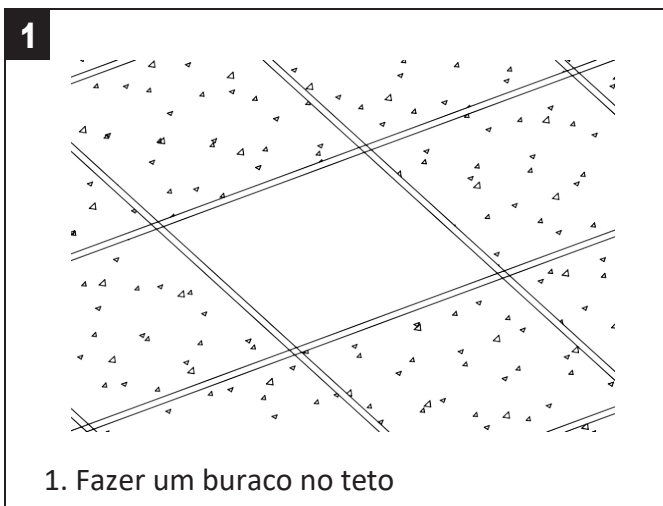

RoHS



UK
CA





Meaningful Innovation.

WEEE Number: 80133970

MANUAL DE INSTRUCȚIUNI

PANOU RETROILUMINAT CU LED

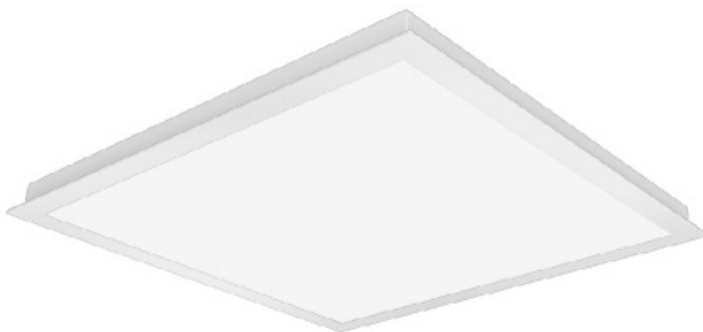

02 YEAR
WARRANTY*

SUPER BRIGHT
180+
LM/WATT EFFICIENCY

DATE TEHNICE

MODEL	VT-60025	DURATA DE VIAȚĂ	20.000 de ore
SKU	23393, 23458	CICLUL ON/OFF	>15,000
FORMA	SQUARE	TEMPERATURA DE FUNCȚIONARE	-10°C până la +35°C
WATTS	25W	TENSIUNE DE INTRARE	AC: 220-240V, 50/60Hz
LUMENI	4500 Lm	IP RATING	IP20
UNGHIIUL FASCICULULUI	110°	TIP DE CAROSERIE	PS+AL+SPCC
CRI	≥80	DIMENSIUNE	595x595x33mm
DF	≥0.9		

INTRODUCERE ȘI GARANȚIE

Vă mulțumim pentru selectarea și cumpărarea produsului V-TAC. V-TAC vă va servi cel mai bine. Vă rugăm să citiți cu atenție aceste instrucțiuni înainte de a începe instalarea și să păstrați acest manual la îndemână pentru consultare ulterioară. Dacă aveți orice altă întrebare, vă rugăm să contactați distribuitorul nostru sau vânzătorul local de la care ați achiziționat produsul. Aceștia sunt instruiți și pregătiți să vă servească la cel mai bun nivel. Garanția este valabilă timp de 2 ani de la data achiziției. Garanția nu se aplică deteriorărilor cauzate de instalarea incorectă sau de uzura anormală. Compania nu oferă nicio garanție împotriva deteriorării oricărei suprafețe din cauza îndepărtării și instalării incorecte a produsului. Produsele sunt potrivite pentru o funcționare de 10-12 Ore pe zi. Utilizarea produsului timp de 24 de ore pe zi ar anula garanția. Acest produs este garantat numai pentru defectele de fabricație.



FR

Cet appareil,
ses accessoires
et cordons
se recyclent

À DÉPOSER
EN MAGASIN



À DÉPOSER
EN DÉCHÈTERIE



Points de collecte sur www.quefairedemesdechets.fr
Privilégiez la réparation ou le don de votre appareil !

În cazul oricărei întrebări/probleme legate de produs, vă rugăm să ne contactați la: support@v-tac.eu
Pentru o gamă mai largă de produse, vă rugăm să contactați distribuitorul nostru sau cei mai apropiați dealeri.

V-TAC EUROPE LTD. Bulgaria, Plovdiv 4000, bul.L.Karavelov 9B

AVERTISMENT

1. Vă rugăm să vă asigurați că opriți alimentarea înainte de a începe instalarea.
2. Instalarea trebuie să fie efectuată de un electrician calificat.
3. Sursa de lumină a acestui corp de iluminat nu este înlocuibilă; atunci când sursa de lumină ajunge la sfârșitul duratei de viață, întregul corp de iluminat trebuie înlocuit.
4. În cazul în care cablul sau cablul flexibil extern al acestui corp de iluminat este deteriorat, acesta trebuie înlocuit exclusiv de producător sau de agentul său de service sau de o persoană calificată similară, pentru a evita un pericol.
5. Numai pentru utilizare în interior.



Acest marcaj indică faptul că acest produs nu trebuie eliminat împreună cu alte deșeuri menajere.



Atenție, Risc de șoc electric

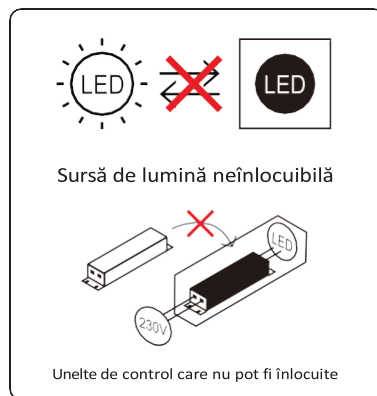

Sursă de lumină neînlocuibilă

Unelte de control care nu pot fi înlocuite



Corpuri de iluminat care nu pot fi acoperite cu material termoizolant.

INSTRUCȚIUNI DE INSTALARE

1

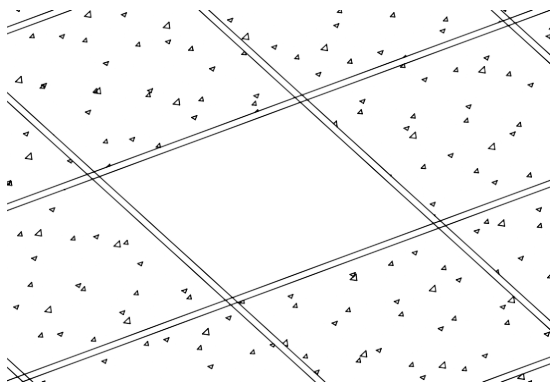

1. Faceți o gaură în tavan

2

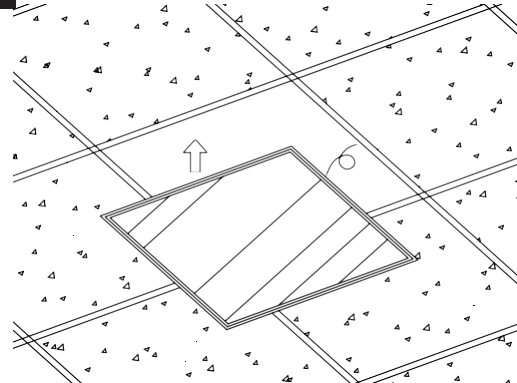

2. Fixați panoul în tavan

3

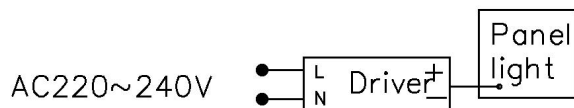

3. Conectați cablul în terminal

4

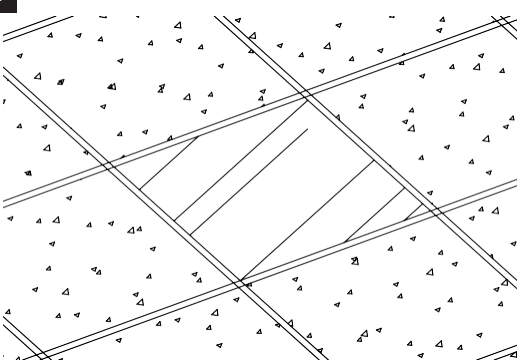

4. Porniți comutatorul și testați panoul

RoHS



UK
CA





Meaningful Innovation.

WEEE Number: 80133970

MANUAL DE INSTRUCCIONES

PANEL RETROILUMINADO POR LEDS

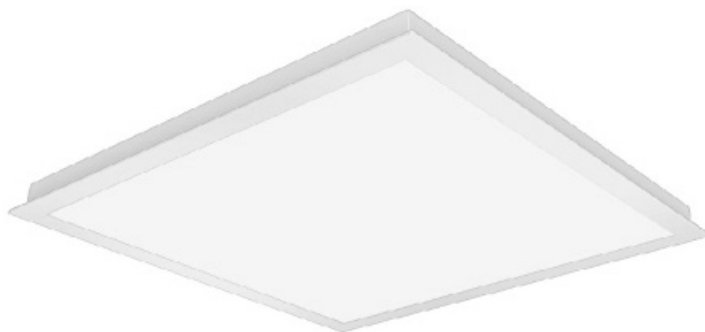

02 YEAR
WARRANTY*

SUPER BRIGHT
180+
LM/WATT EFFICIENCY

DATOS TÉCNICOS

MODELO	VT-60025	VIDA ÚTIL	20.000 horas
SKU	23393, 23458	CICLO ON/OFF	>15,000
SHAPE	CUADRADO	TEMPERATURA DE FUNCIONAMIENTO	-10°C a +35°C
WATTS	25W	TENSIÓN DE ENTRADA	CA: 220-240 V, 50/60 Hz
LUMENS	4500 Lm	CLASIFICACIÓN IP	IP20
ÁNGULO DEL HAZ	110°	TIPO DE CARROCERÍA	PS+AL+SPCC
CRI	≥80	DIMENSIÓN	595x595x33mm
DF	≥0.9		

INTRODUCCIÓN Y GARANTÍA

Gracias por seleccionar y comprar un producto V-TAC. V-TAC le servirá lo mejor posible. Lea atentamente estas instrucciones antes de iniciar la instalación y conserve este manual a mano para futuras consultas. Si tiene cualquier otra duda, póngase en contacto con nuestro distribuidor o vendedor local al que haya comprado el producto. Están formados y preparados para atenderle lo mejor posible. La garantía es válida durante 2 años a partir de la fecha de compra. La garantía no se aplica a los daños causados por una instalación incorrecta o un desgaste anormal. La empresa no ofrece ninguna garantía contra daños en cualquier superficie debidos a una incorrecta retirada e instalación del producto. Los productos son adecuados para un funcionamiento de 10-12 Horas diarias. El uso del producto durante 24 horas al día anularía la garantía. Este producto está garantizado únicamente por defectos de fabricación.



FR

Cet appareil, ses accessoires et cordons se recyclent

À DÉPOSER EN MAGASIN



À DÉPOSER EN DÉCHÈTERIE



Points de collecte sur www.quefairedemesdechets.fr
Privilégiez la réparation ou le don de votre appareil !

ADVERTENCIA

1. Asegúrese de desconectar la alimentación antes de iniciar la instalación.
2. La instalación debe ser realizada por un electricista cualificado.
3. La fuente de luz de esta luminaria no es sustituible, cuando la fuente de luz llegue al final de su vida útil deberá sustituirse toda la luminaria.
4. Si el cable o cordón flexible externo de esta luminaria está dañado, deberá ser sustituido exclusivamente por el fabricante o su agente de servicio o una persona cualificada similar para evitar riesgos.
5. Sólo para uso en interiores.

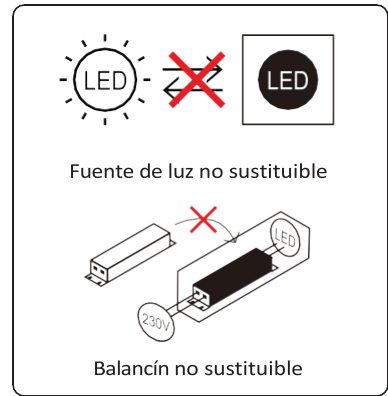

Esta marca indica que este producto no debe eliminarse con otros residuos domésticos.



Precaución, riesgo de descarga eléctrica



Luminarias no aptas para cubrir con material aislante térmico.

INSTRUCCIONES DE INSTALACIÓN

1

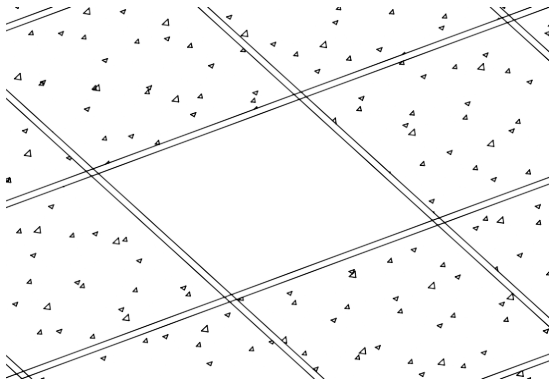

1. Hacer un agujero en el techo

2

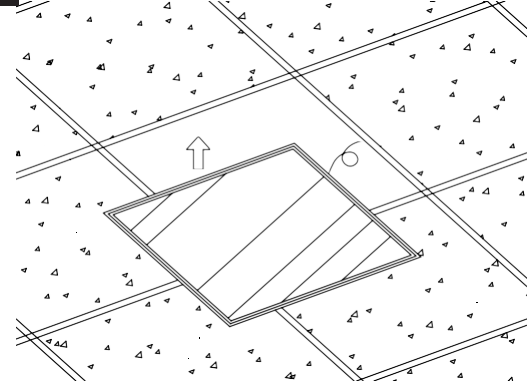

2. Fijar el panel al techo

3

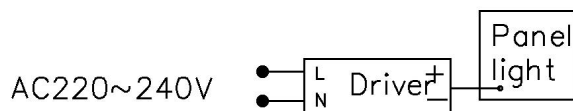

3. Conecte el cable al terminal

4

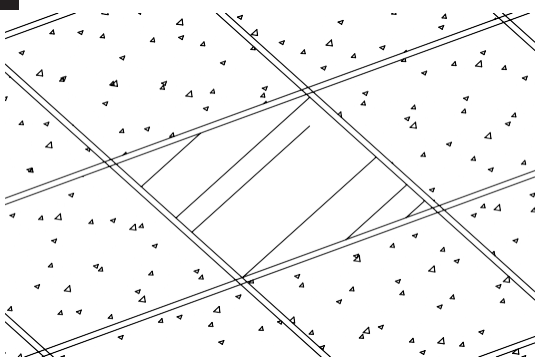

4. Encienda el interruptor y pruebe el Panel

RoHS



UK
CA

