



Meaningful Innovation.

WEEE Number: 80133070

INSTALLATION INSTRUCTION LED DESIGNER CEILING LIGHT

TECHNICAL DATA

MODEL	VT-7915
WATTS	38W
LUMENS	4100LM
BEAM ANGLE	360°
MATERIAL	Metal+Silicone+Acrylic
BASE SIZE	L200 x W200 x H35mm
DIMENSION	880 x 105mm
INPUT POWER	AC: 180-240V, 50Hz



INTRODUCTION & WARRANTY

Thank you for selecting and buying V-TAC product. V-TAC will serve you the best. Please read these instructions carefully before starting the installation and keep this manual handy for future reference. If you have any another query, please contact our dealer or local vendor from whom you have purchased the product. They are trained and ready to serve you at the best. The warranty is valid for 2 years from the date of purchase. The warranty does not apply to damage caused by incorrect installation or abnormal wear and tear. The company gives no warranty against damage to any surface due to incorrect removal and installation of the product. The products are suitable for 10-12 Hours Daily operation. Usage of product for 24 Hours a day would void the warranty. This product is warranted for manufacturing defects only.

02 YEARS WARRANTY
Adjustable Height

WARNING!

- Please make sure to turn off the power before starting the installation.
- Installation must be performed by a qualified electrician.
- The light source of this luminaire is not replaceable; when the light source reaches its end of life the whole luminaire shall be replaced.
- Proper grounding should be ensured throughout the installation.

For Indoor Use only

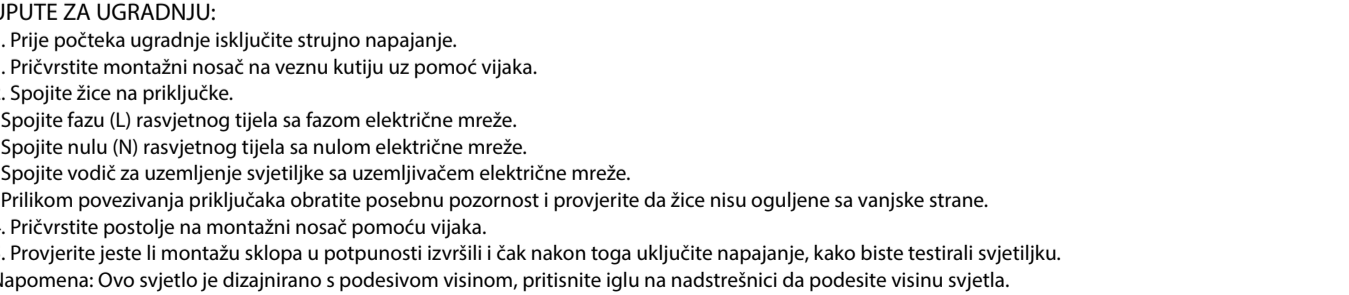
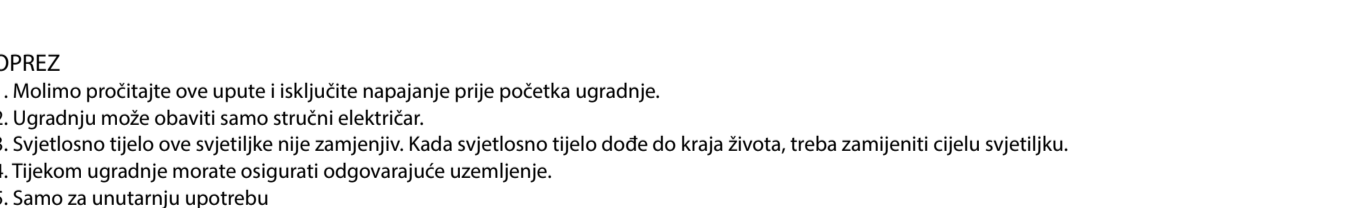
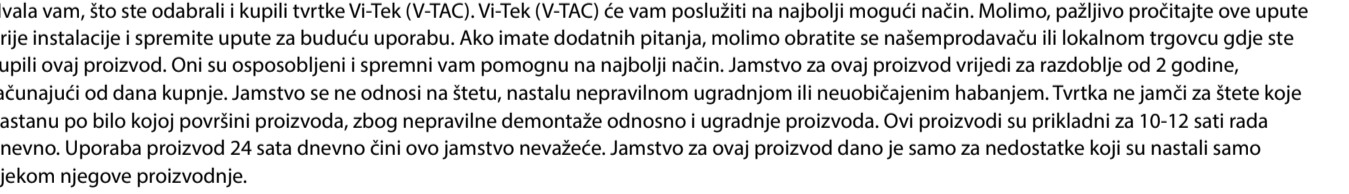
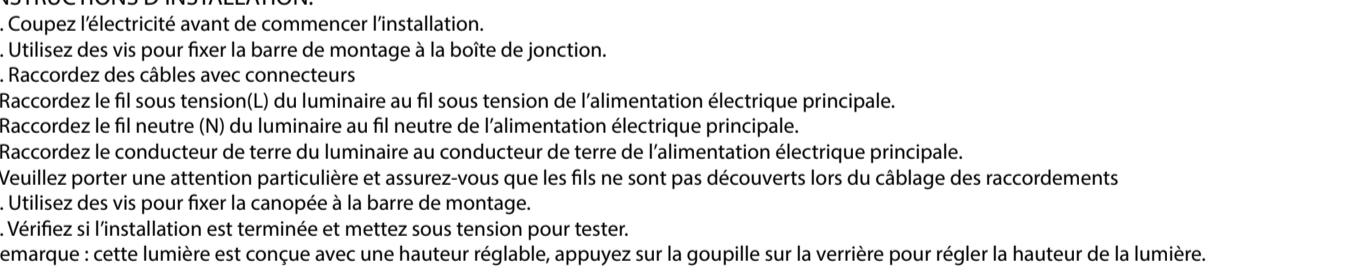
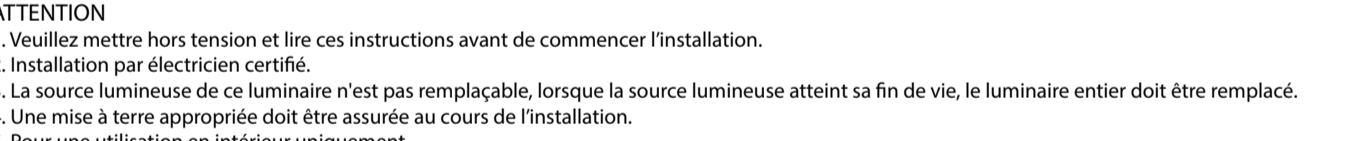
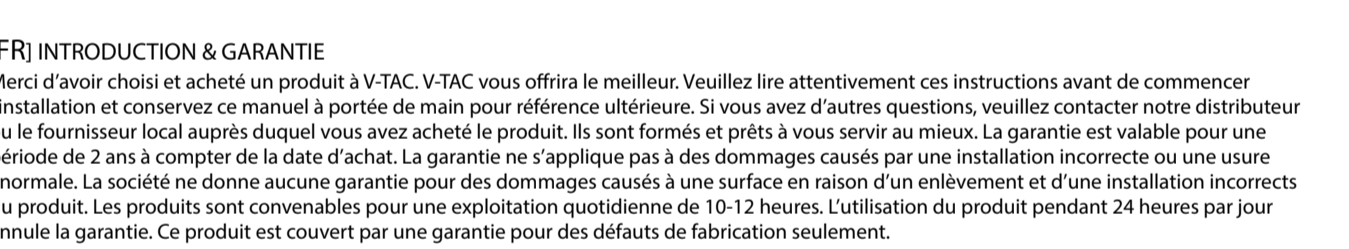
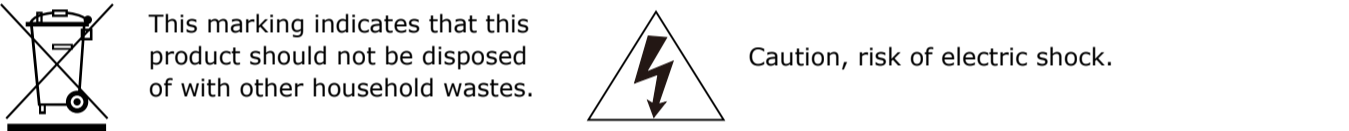



Meaningful Innovation.

WEEE Number: 80133070

INSTALLATION INSTRUCTION LED DESIGNER CEILING LIGHT

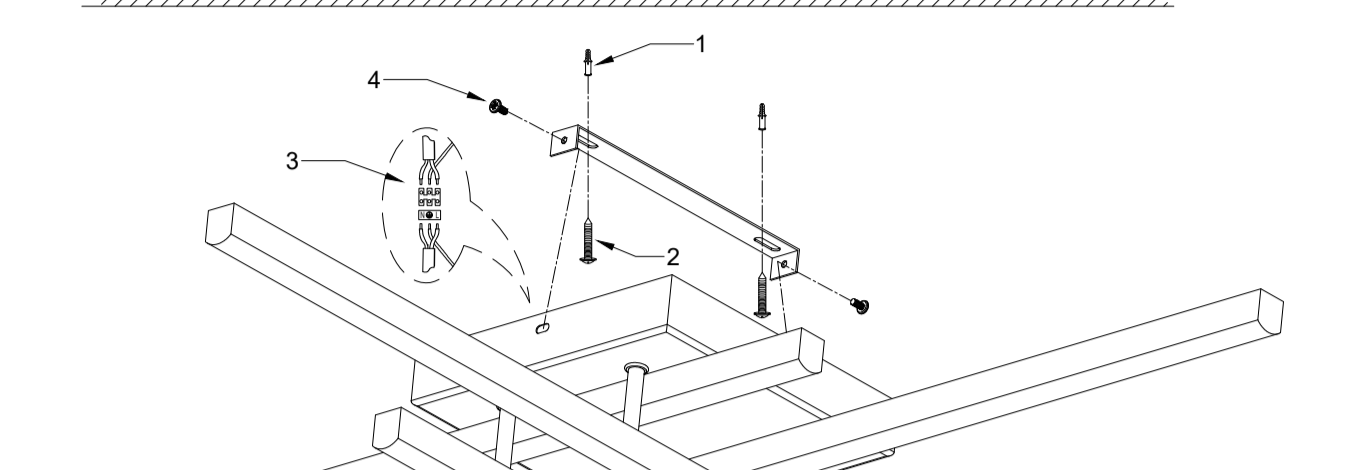

INTRODUCTION & WARRANTY

Thank you for selecting and buying V-TAC product. V-TAC will serve you the best. Please read these instructions carefully before starting the installation and keep this manual handy for future reference. If you have any another query, please contact our dealer or local vendor from whom you have purchased the product. They are trained and ready to serve you at the best. The warranty is valid for 2 years from the date of purchase. The warranty does not apply to damage caused by incorrect installation or abnormal wear and tear. The company gives no warranty against damage to any surface due to incorrect removal and installation of the product. The products are suitable for 10-12 Hours Daily operation. Usage of product for 24 Hours a day would void the warranty. This product is warranted for manufacturing defects only.

02 YEARS WARRANTY
Adjustable Height

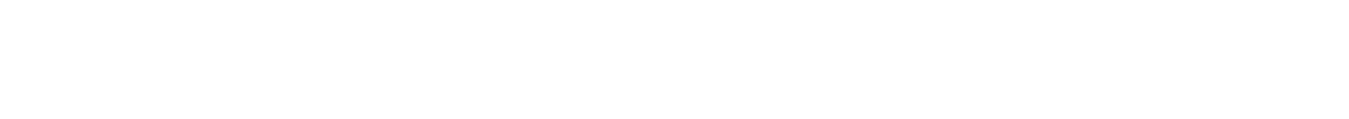
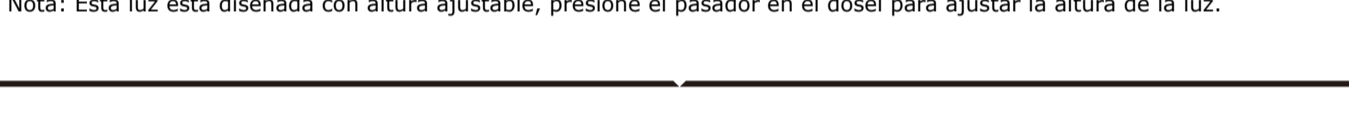
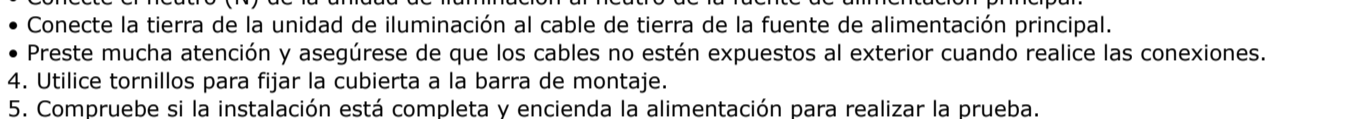
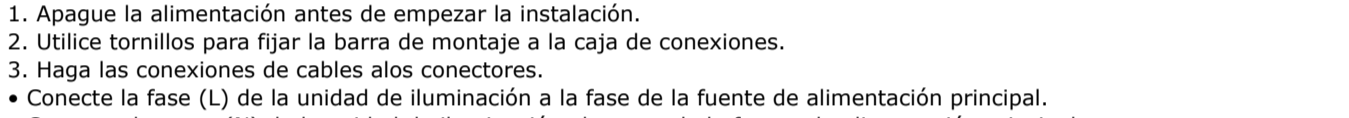
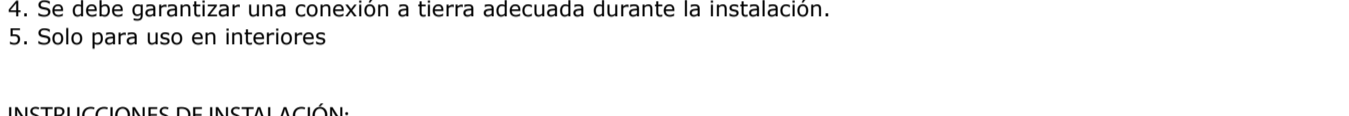
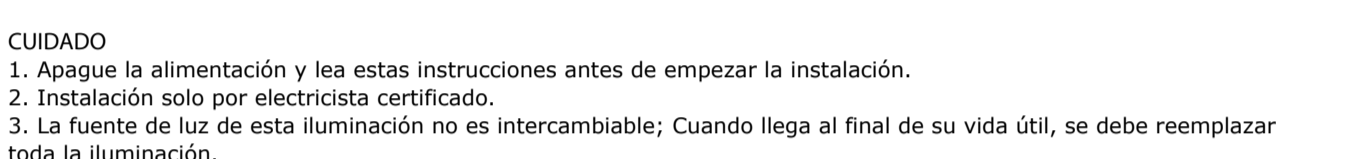
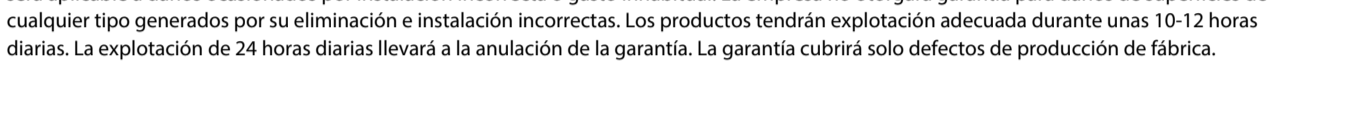
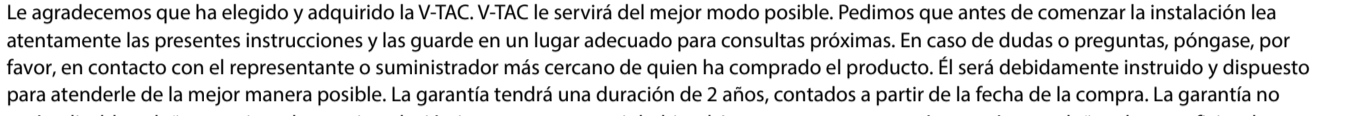
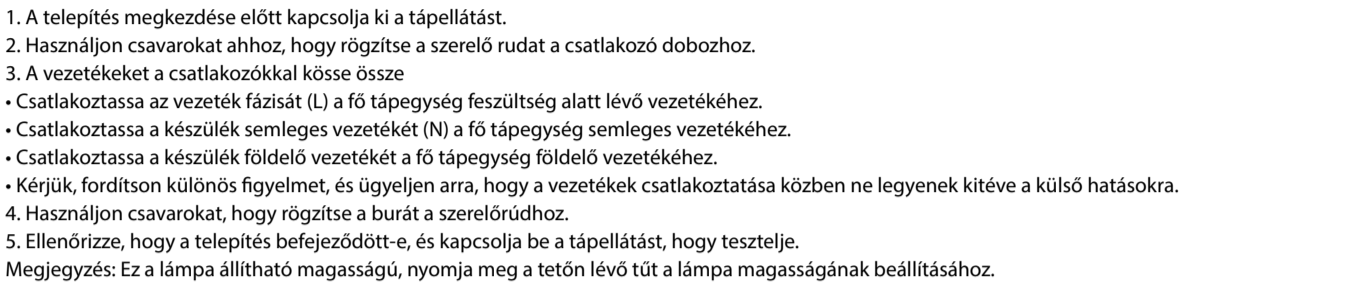
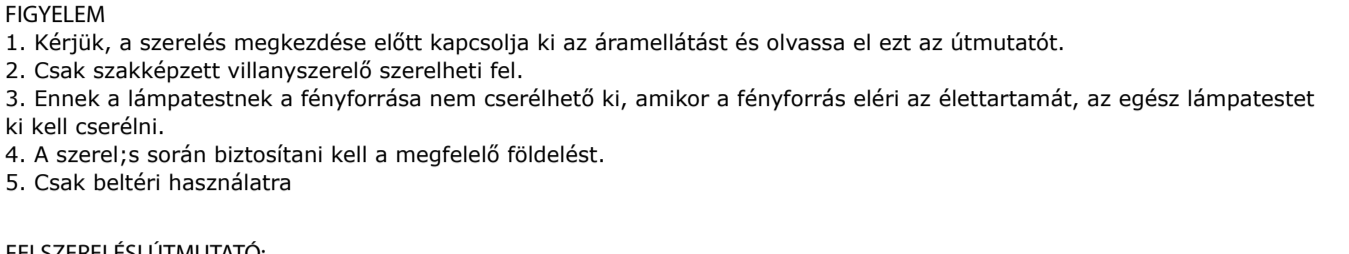
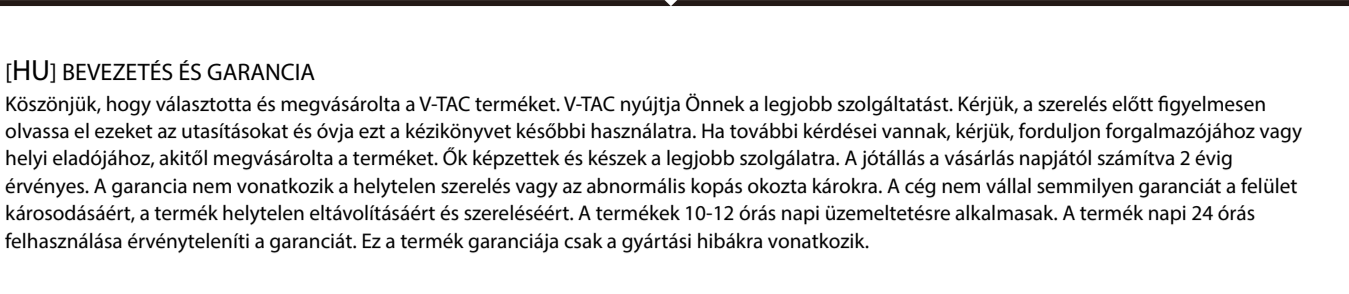
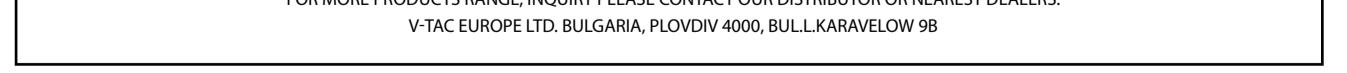
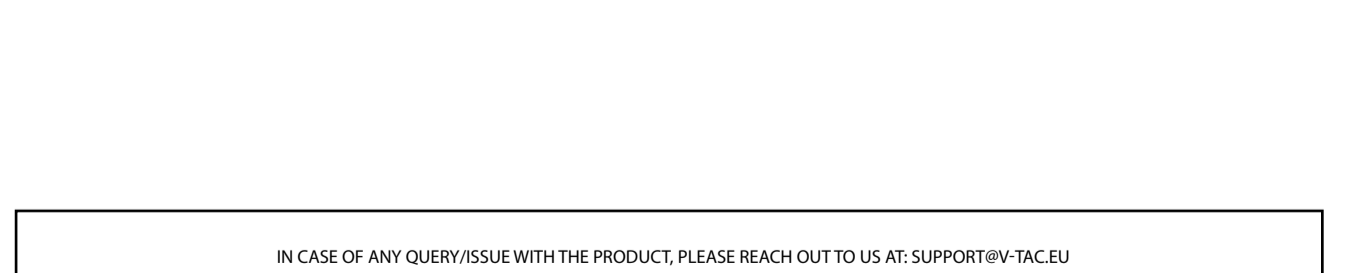
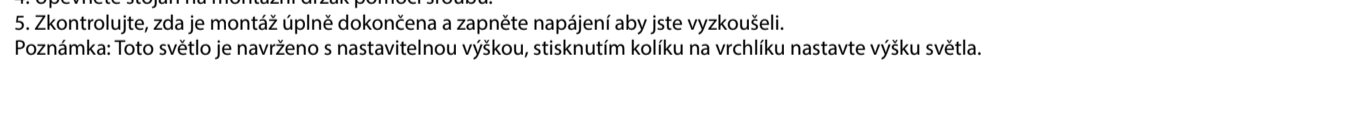
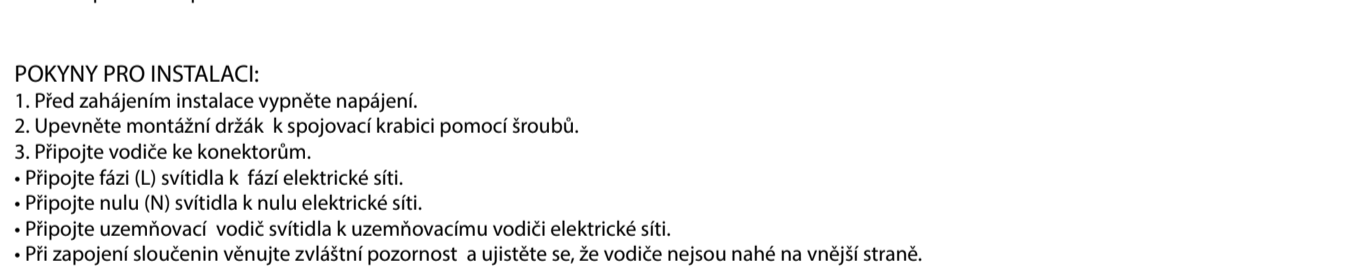
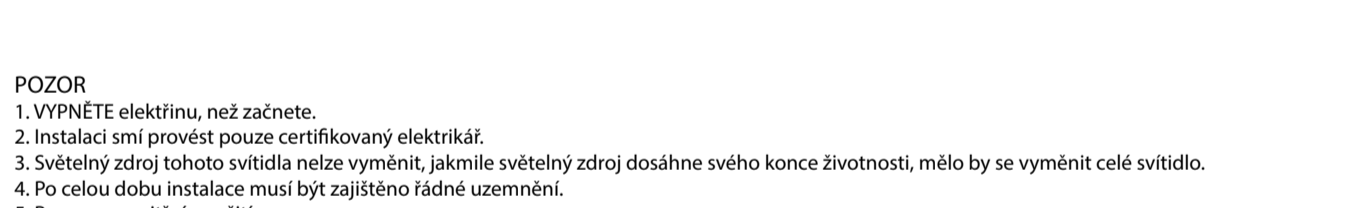
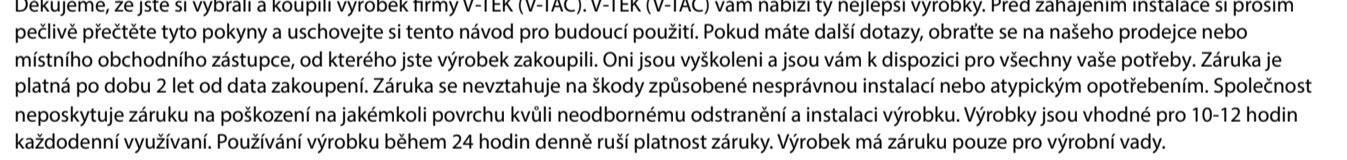
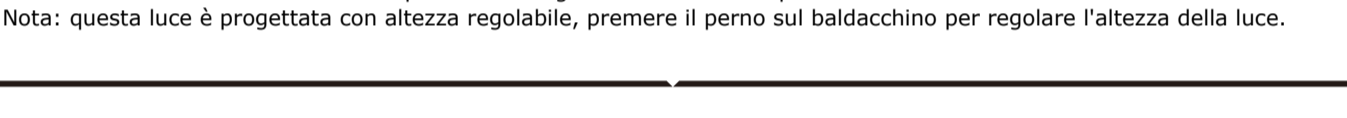
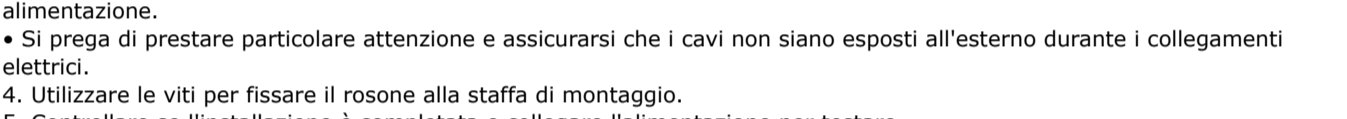
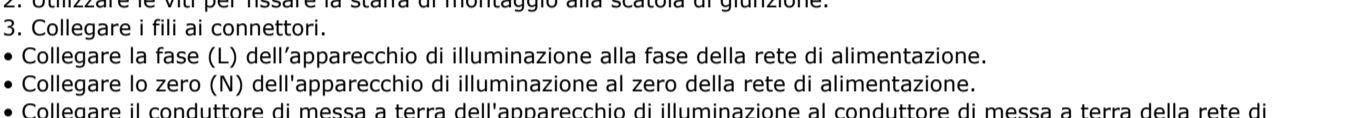
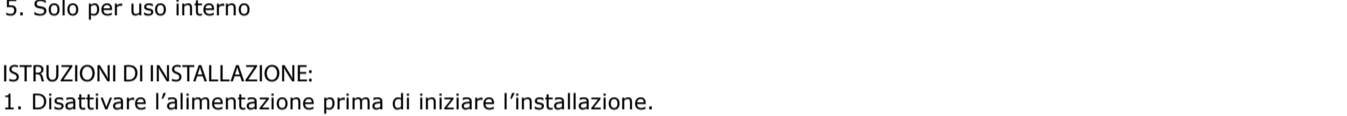
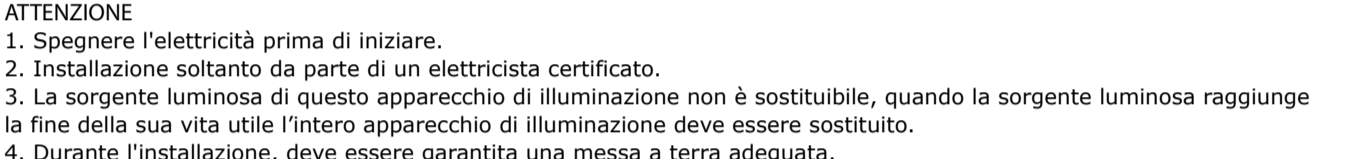
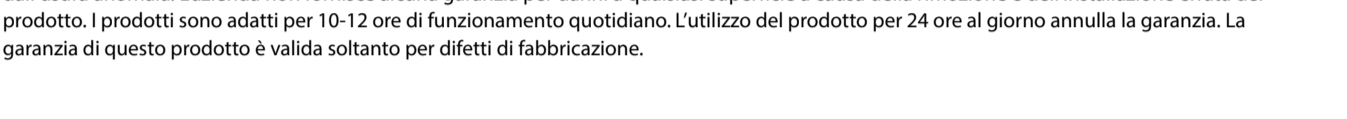
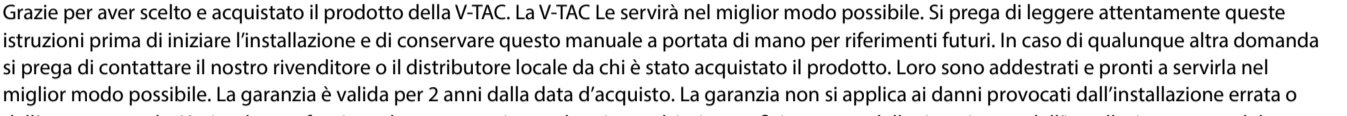
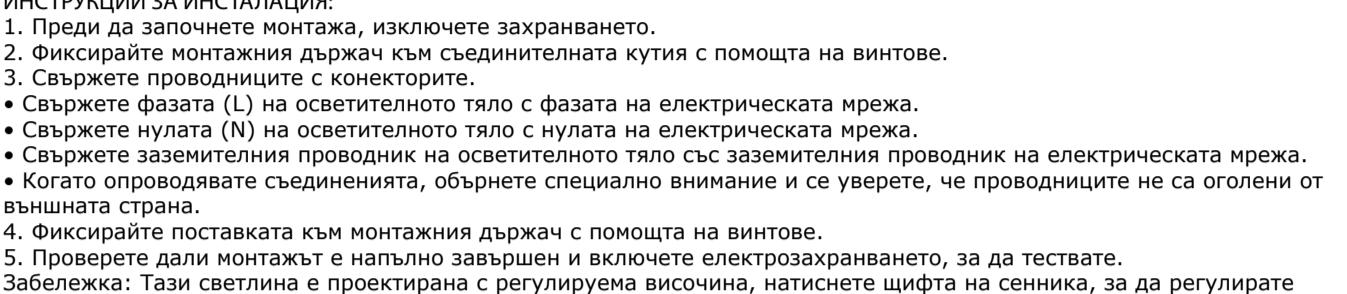
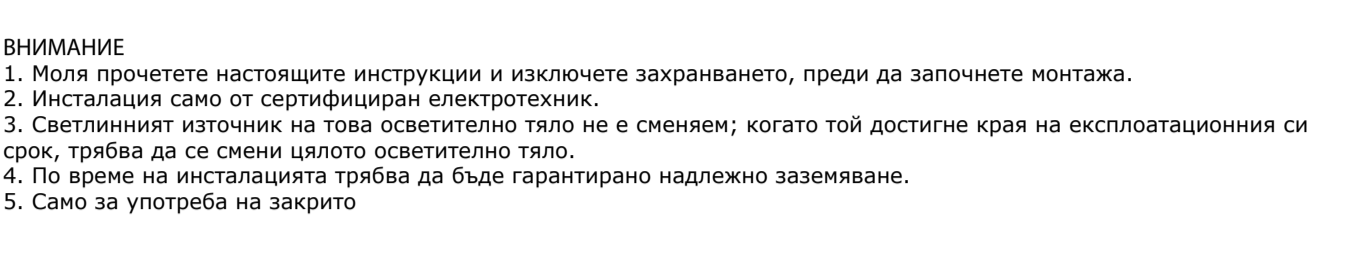
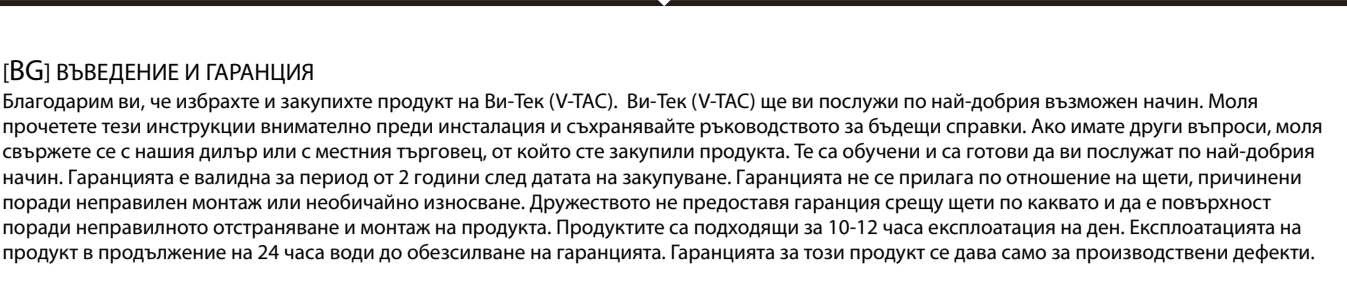
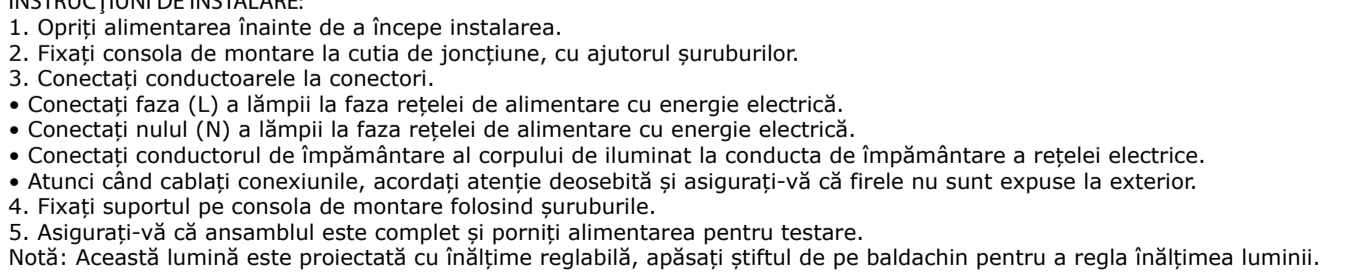
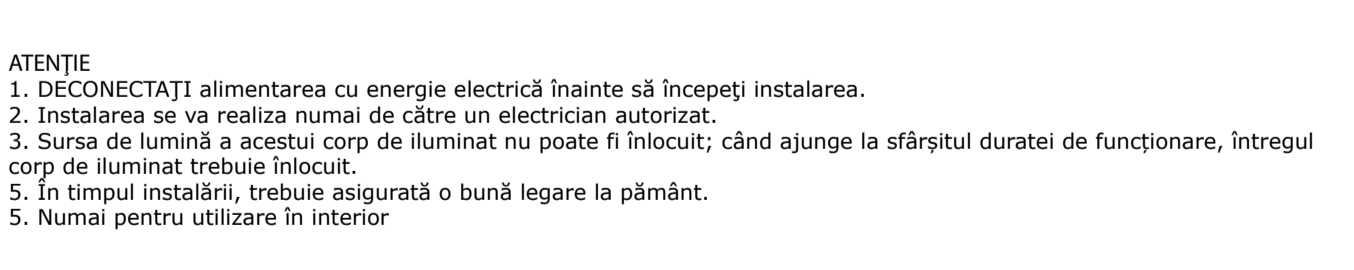
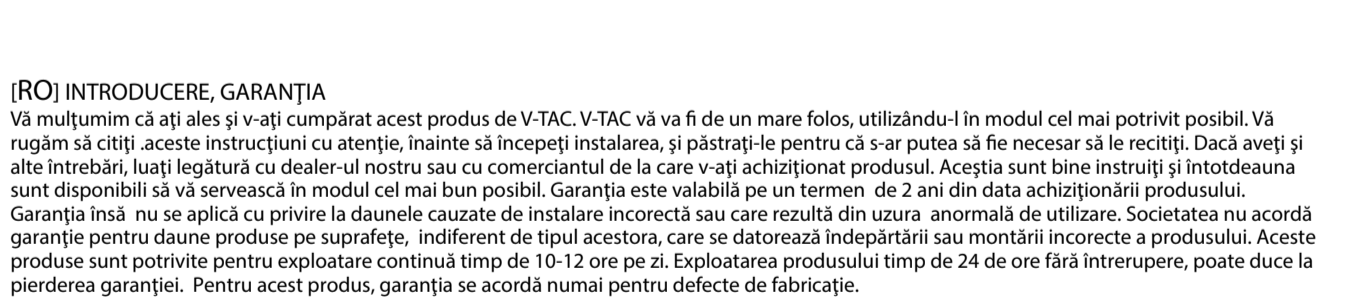
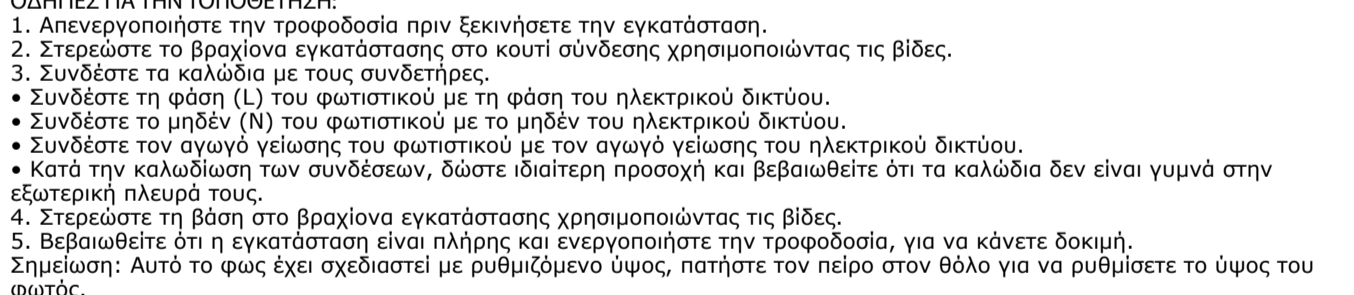
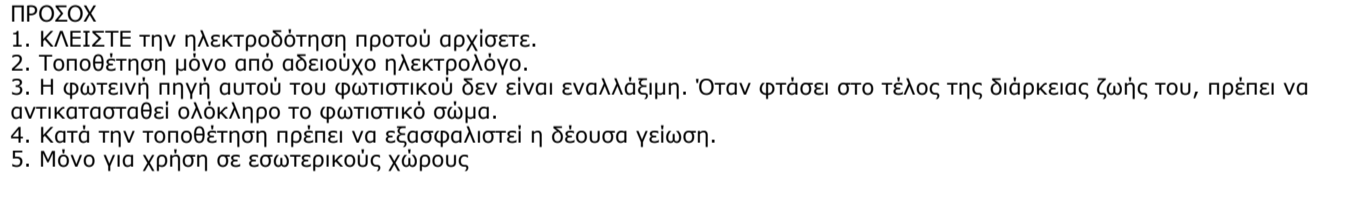
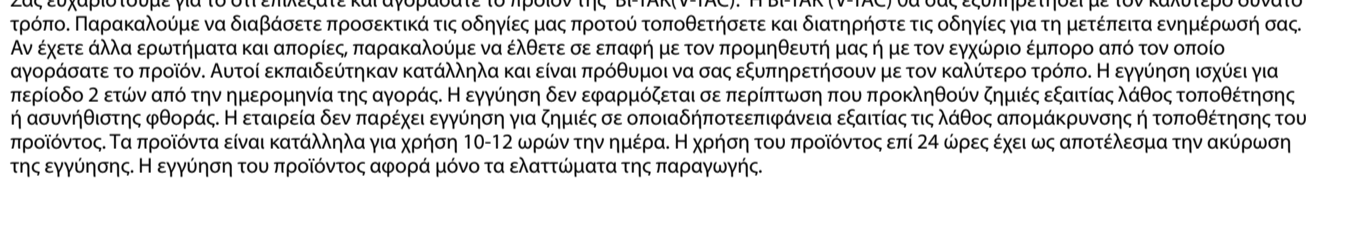
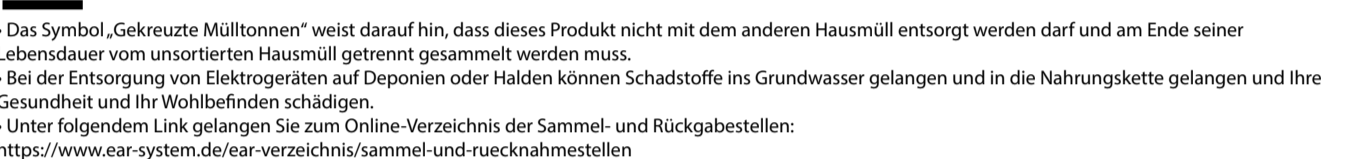
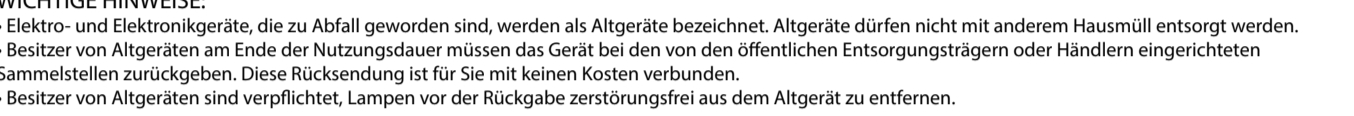
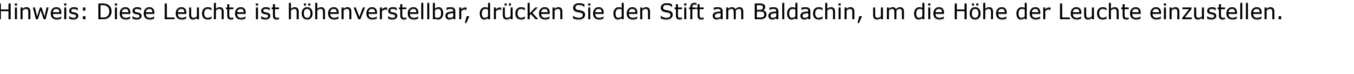
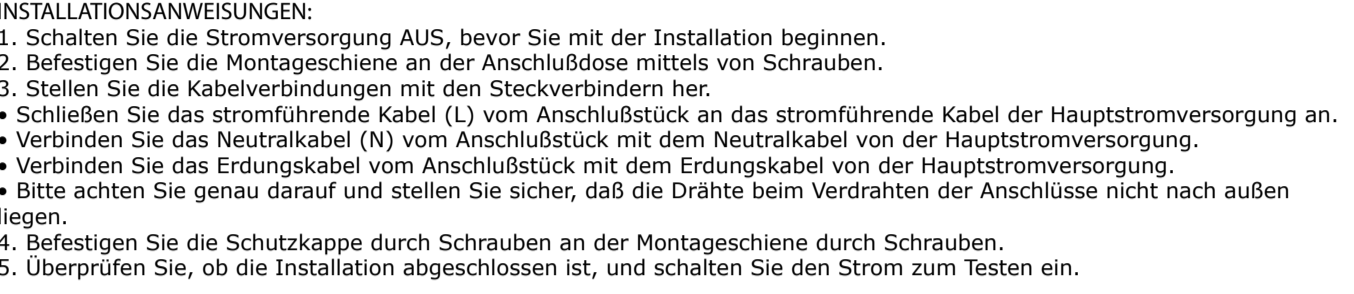
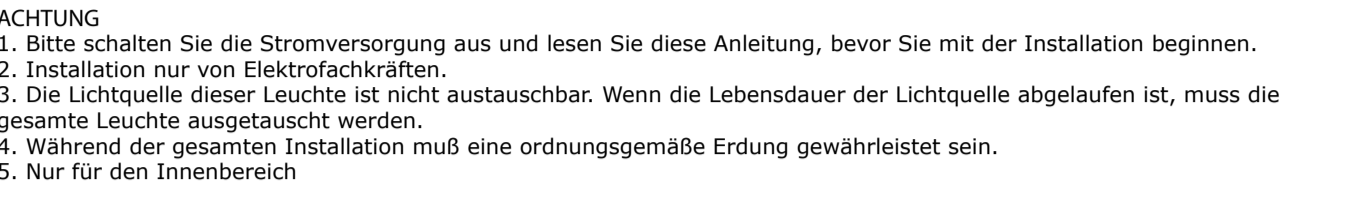
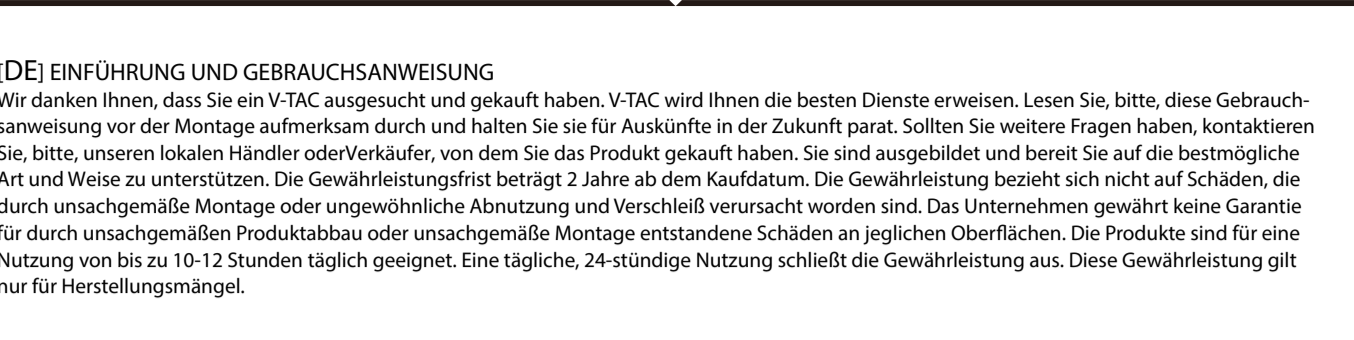
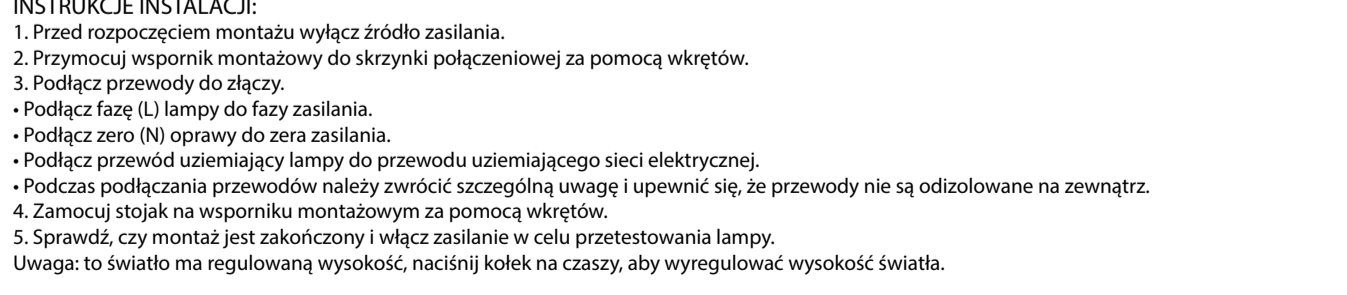
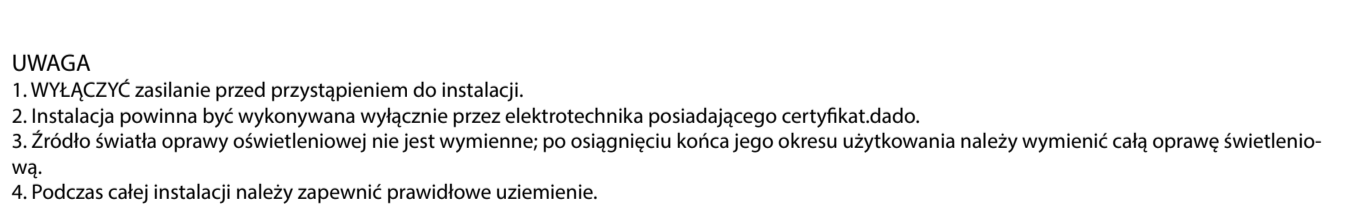
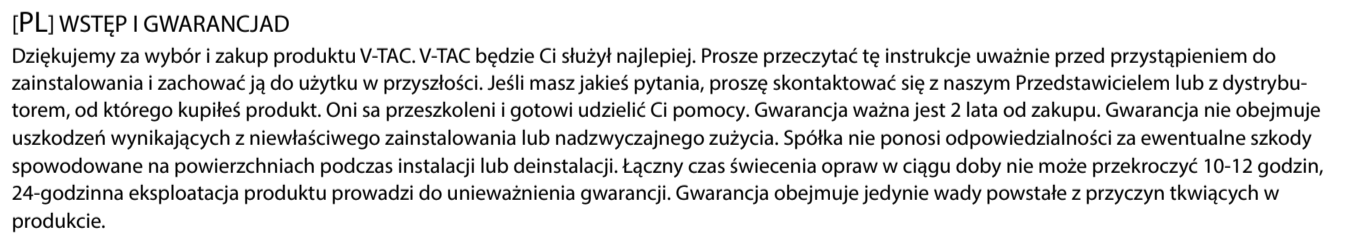
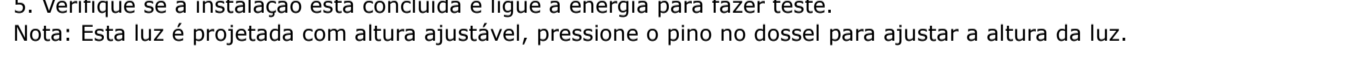
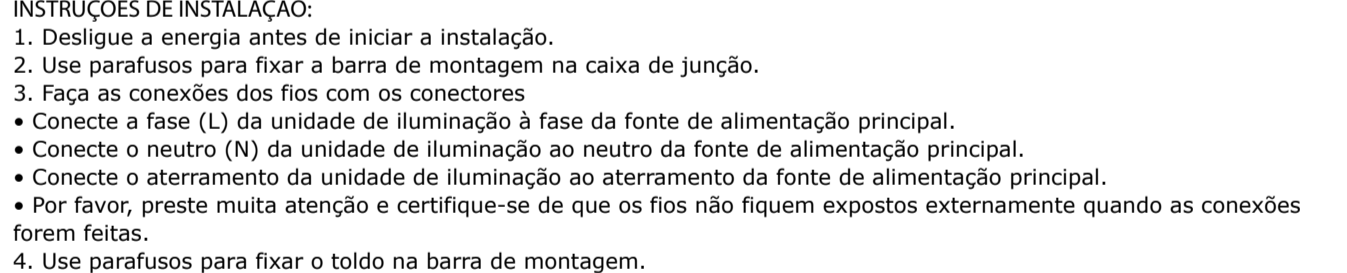
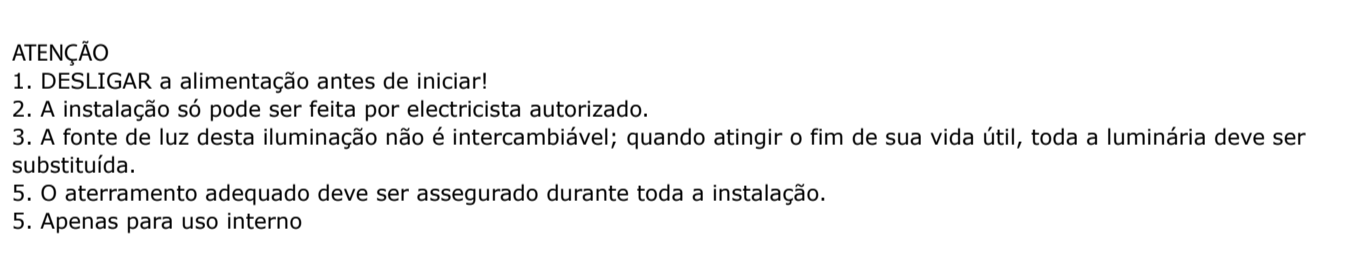
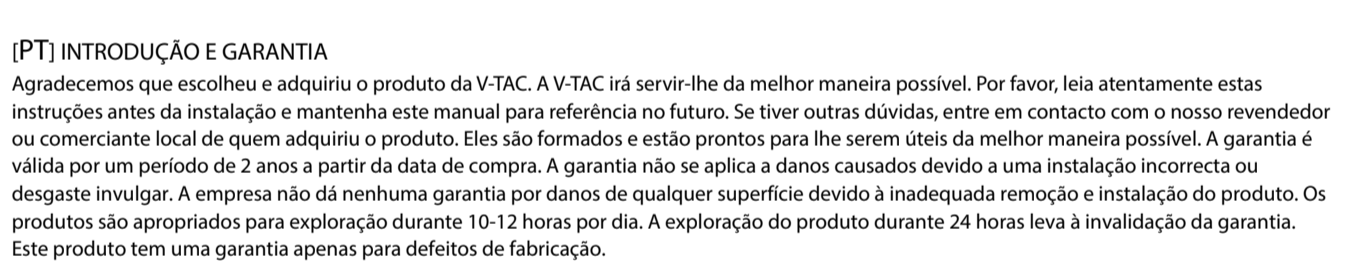
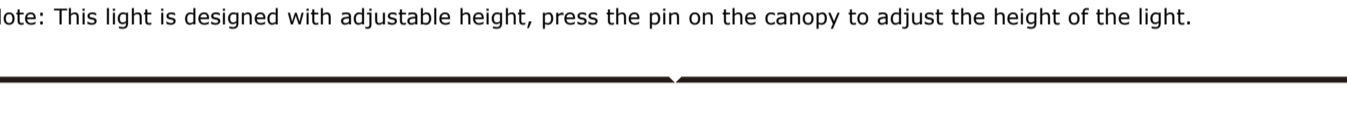
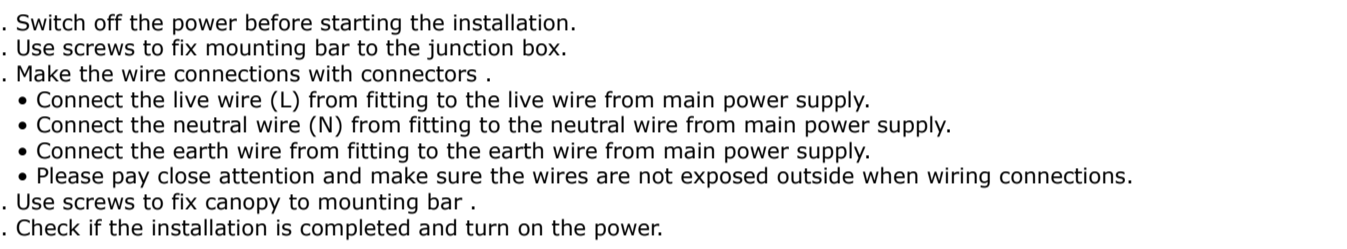
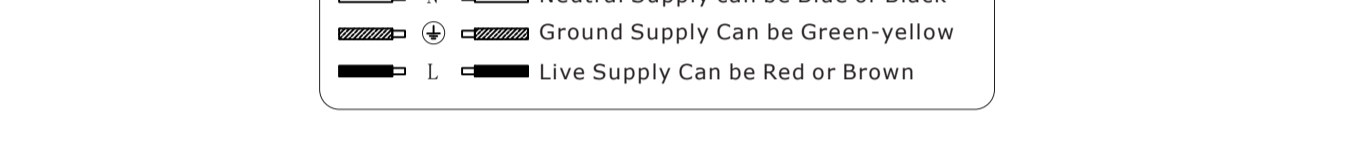

IN CASE OF ANY QUERIES/ISSUES WITH THE PRODUCT, PLEASE REACH OUT TO US AT: SUPPORT@V-TAC.UK
FOR MORE PRODUCTS RANGE, INQUIRY PLEASE CONTACT OUR DISTRIBUTOR OR NEAREST DEALERS.
V-TAC EUROPE LTD, BULGARIA, PLOVDIV 4000, BUL.BALKANAVELUD 98